

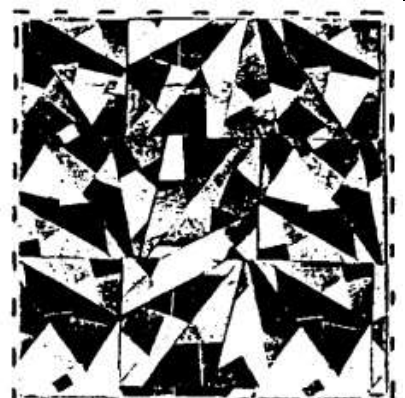





**Hologrammmarken / Hologram Device Marks**

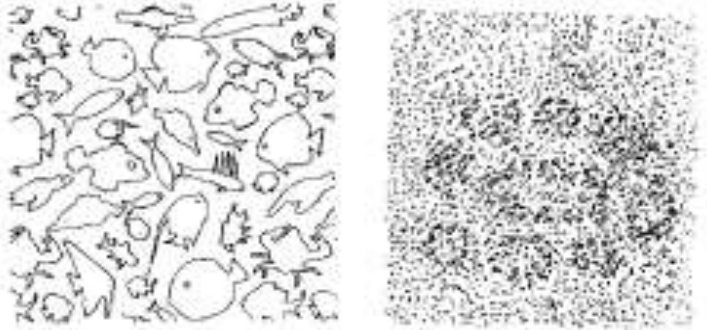
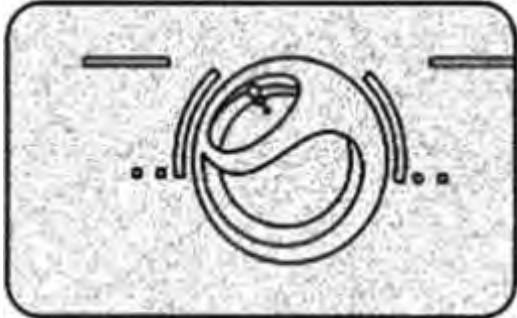

Land Country	Aktenz. Serial#	Marke Mark	Klasse Class	Anmelder Applicant	Status *	Check
AU	930971		22 24 25	Gulfstream Trading Co	E W	2004
CA	835927	 <p>The trade-mark consists of a hologram reflecting all colours, or any colour, of the light spectrum (an example of which appears in the graphic representation of the mark which is attached hereto and which forms part of this application) which is applied to the packaging of wares stated in the specification of wares. A formal drawing, the purpose of which is to depict the background design of the hologram, is attached hereto; the square shape shown in dashed outline does not form part of the trade-mark</p>	3	SmithKline Beecham	E W	2002

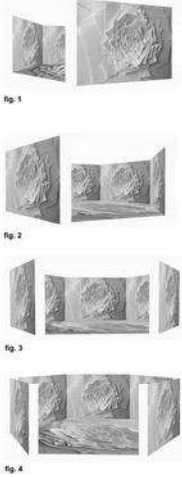

CA	1002075	 <p>The trademark consists of a hologram applied to the wares, and as viewed from one angle depicts a repeating pattern of roses, and from another angle a repeating pattern of butterflies, with these patterns being superimposed in whole or in part when viewed from still other angles. A graphic representation of the mark illustrating the separate repeating patterns is attached to form a part of the application</p>	18	JEANNE LOTTIE'S FASHION INCORPORATED	E W	2001
CA	1002079	 <p>The trademark consists of a hologram applied to the wares, and as viewed from one angle depicts a repeating pattern of fish, and from another angle a repeating pattern of coral, with these patterns being superimposed in whole or in part when viewed from still other angles. A graphic representation of the mark illustrating the separate repeating patterns is attached to form a part of the application.</p>	18	JEANNE LOTTIE'S FASHION INCORPORATED	E W	2001

CA	1404448	 <p>The stippling in the mark represents the hologram with iridescent effect superimposed on the design elements</p>	9	Sony Ericsson Mobile	E W	2014
CH	786133		2 9 28 38 41		R	2022

CH	804850		9 25	<b>Your Stories</b>	R	2023
CZ	346325		10 20 35 37	<b>Trachea</b>	R	2015
CZ	378904	 <p data-bbox="1189 1315 1375 1342">See 5 sec mp4</p>	5 9	<b>J Horvath</b>	R	2020

<p>DE</p>	<p>30219764 24 W (pat) 102/03</p>	 <p>Gegenstand der Marke ist ein für Verpackungen von Eau de Toilette bestimmtes, konturenunbestimmtes Holo-gramm mit altrosé-farbener, metallisch-glänzender Grundfarbe. Bei Lichteinfall scheinen vertikale geradlinige Streifen in den Spektralfarben von violett über blau, grün, gelb, orange bis rot auf. Die Spektralfarbenstreifen weisen Abstände von je ca. 5 cm auf. Die silbrig-glänzende Oberfläche des Hologramms entspricht dem Farbton „Cool Gray 1 C“ des Farbsystems PANTONE formula guide solid coated. Für den roten Farbton findet „Process Magenta C“ des Farbsystems PANTONE formula guide solid coated in der Weise Verwendung, daß mit einem Farbauftrag in einem Raster von 70 eine Farbabdeckung von 30% erreicht wird. Wenn bei sonnigem Wetter der Gegenstand der Marke <b>senkrecht (90° zur Horizontalen)</b> in Augenhöhe des Betrachters im Freien plaziert wird und die Sonne hinter dem Betrachter steht, weisen die Spektralfarbenstreifen eine Breite von je 2 mm auf. Dabei ergeben sich bei verschiedenen Blickwinkeln – von links nach rechts – folgende, jeweils von oben nach unten stufenlos verlaufende Anordnungen von Spektralfarben: <b>30°: violett, blau, grün gelb; 60°: grün, gelb, orange, rot; 90° orange, rot, violett, blau, grün; 120°: rot, violett, blau, grün, gelb; 150°: blau, grün, gelb, orange.</b> The mark is a shapeless hologram for use as wrapping for eau de toilette with a rose metallic glittering base, the silver metallic glittering being cool grey 1C Pantone formula guide solid coating and rose being process magenta C Pantone formula guide solid coating. Upon action of light vertical rectilinear lines (about 5 cm) in the spectral colours violet, blue, green yellow and orange appear. The hologram is an embossed hologram wherein magenta is printed on the silver surface and then coated with a varnish. In case of sunny</p>	<p>3</p>	<p>Parfum Christian Dior</p> 	<p>E A W</p>	<p>2005</p>
-----------	---------------------------------------	--	----------	--	--------------	-------------

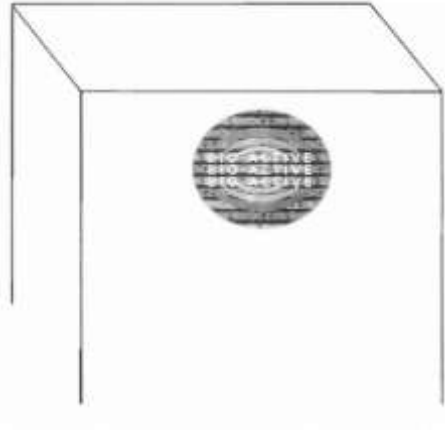

		weather and when placing the wrapping perpendicularly to the viewer outside and the sun being behind the viewer, the lines of spectral colours have a width of 2 mm. So the following arrangements of spectral colours arise depending on the different views: 30°: violet, blue, green, yellow; 60°: green, yellow, orange, red; 90°: orange, red, violet, blue, green; 120°: red, violet, blue, green, yellow; 150°: blue, green, yellow, orange. See right-hand side.				
DE	30453281	 <p>weiss, silber, orangegelb, blaugrün / white silver, orange yellow, bluegreen</p>	9 16	Nikon GmbH	R	2004
DE	30453263	 <p>weiss, silber, orangegelb, blaugrün / white silver, orange yellow, bluegreen</p>	9 16	Nikon GmbH	R	2004

DE	302023107210		16 25 28 41	SSV Ulm 1846	R	2023
EM	1787456	 <p data-bbox="696 839 853 871">Bio – Active</p>	3 5	Bioclean B.V.	R	2003
EM	2117034	 <p data-bbox="1218 1254 1375 1286">Video Future</p>	9 38 41	GDS Video	R	2002

EM	255914434	 <p>Die in der Anlage gezeigte Marke besteht aus holografischem Papier, das das Farbenspektrum in schrägen, parallelen Linien auf die Packungs-oberfläche reflektiert; die punktierten Linien auf der Zeichnung gehören nicht zur Marke und dienen nur der 3-D-Illustration..          Farbangabe : Das gesamte Farben-spektrum (Hologramm)..; The mark as shown in the attachment consists of holographic paper that reflects the spectrum of colour in a pattern of oblique, parallel lines applied to the surface of a package; the dotted lines shown in the drawing form no part of the mark, and are for 3-d illustrative purposes only..          Indication of colour : The whole spectrum of colour (hologram)..</p>	34	Eve Holding Inc.	R	2004
----	-----------	--	----	------------------	---	------



EM	2788362	 <p data-bbox="786 587 882 619">Midland</p>	16 34 35	United Tobacco Corp.	E W	2005
EM	2886083	 <p data-bbox="555 1139 1442 1281">The mark consists of a hologram in the shape of a square applied to the goods; the content of the hologram is not claimed as a feature of the mark; the drawing is lined for the colour gold or silver but colour is not claimed as a feature of the mark</p>	16 28	The upper deck Co	E W	2005





EM	2946556	 <p style="text-align: right;">Sea Island                      The</p> <p>mark consists of a hologram in the shape of a square applied to the goods; the content of the hologram is not claimed as a feature of the mark; the drawing is lined for the colour gold or silver but colour is not claimed as a feature of the mark. Die Marke besteht aus einem Hologramm</p>	22 24 25	Gulfstream Trading Company	E W	2005
EM	3908001	 <p>If the viewer inclines the hologram slightly to the left, depending on the incidence of light he will see the following shades: 1st.left wreath: green, yellow, red, circle: lilac, grey.If he turns it further to the left, depending on the incidence of light he will see the following shades: 2nd.left wreath: lilac, blue, circle: blue, lilac.If the viewer turns the hologram still further to the left, depending on the incidence of light he will see the</p>	16 17 40	Cass Laminierungs GmbH	E W	2005

		<p>following shades: 3rd.left wreath: dark lilac, circle: yellow/ blue.If the hologram is turned from the centre slightly to the right, depending on the incidence of light the viewer will see the following shades: 1st.right wreath: lilac, blue, circle: yellow, black.If he turns it further to the right, depending on the incidence of light the viewer will see the following shades: 2nd.right wreath: blue, grey, lilac, circle: grey, lilac, if he turns it still further to the right, depending on the incidence of light the viewer will see the following shades: 3rd.right wreath: yellow, red, green, circle: lilac..Neigt der Betrachter das Hologramm leicht nach links, so erkennt er jenach Lichteinfall die Darstellung in folgenden Farbnuancen: 1. links Kranz: Grün, Gelb, Rot, Kreis: Lila, Grau. Bei einer weiteren Drehung nach links nimmt der Betrachter je nach Lichteinfall folgende Farbnuancen wahr: 2. links Kranz: Lila, Blau, Kreis: Blau, Lila. Dreht der Betrachter das Hologramm noch weiter nach links erkennt er je nach Lichteinfall folgende Farbnuancen: 3. Links Kranz: Dunkellila, Kreis: Gelb/ Blau. Wird das Hologramm von der Mitte aus leicht nach rechts gedreht, so nimmt der Betrachter je nach Lichteinfall folgende Farbnuancen wahr: 1. rechts Kranz: Lila, Blau, Kreis: Gelb, Schwarz. Bei einer weiteren Drehung nach rechts nimmt der Betrachter je nach Lichteinfall folgende Farbnuancen wahr: 2. rechts Kranz: Blau, Grau, Lila, Kreis: Grau, Lila, Bei einer weiteren Drehung nach rechts nimmt der Betrachter je nach Lichteinfall folgende Farbnuancen wahr: 3. rechts Kranz: Gelb, Rot, Grün, Kreis: Lila.</p>				
EM	5208095	 <p>The trademark is rectangular in shape with rounded edges and is placed on the</p>	9 38	Sony Ericsson Mobile communications	E W	2007

		<p>product. The trademark will appear to shift and various elements will come into focus, alternatively disappear, as the viewer sees the mark from different angles. Elements include, but are not exclusively made up of, a circular shaped figure appearing to hold a round ball within, and the opening holding the ball being divided into two asymmetrical parts, by a curved stripe and the text sony ericsson in various shapes and sizes. Colour and elements will shift with light and angle of viewpoint and focus.. Rechteckige Form mit abgerundeten Ecken, wird auf der Ware appliziert, Marke verschiebt sich und verschiedene Elemente erscheinen oder verschwinden je nach Blickwinkel des Betrachters, zu diesen Elementen zählen unter anderem eine kreisförmige Figur mit einem runden Ball darin, die Öffnung hält den Ball, wobei dieser durch einen gekrümmten Streifen in zwei asymmetrische Teile geteilt ist, der Text sony ericsson in verschiedenen Formen und Größen, die Farben und Elemente variieren je nach Beleuchtung, Blickwinkel und Fokus..</p>				
EM	12383171	 <p>The trademark consists of a hologram composed of the text "PLANTE SYSTEM FRANCE" and four circles, in silver relief on violet holographic paper with highlights placed horizontally / Besteht aus einem Hologramm, das den Text "PLANTE SYSTEM FRANCE" und 4 Kreise beinhaltet und das sich in silberfarbener Reliefdarstellung auf violetterem holografischem Papier mit waagrecht verlaufenden Reflexen befindet</p> <p>Trademark Type changed from "fig." to "hologram" !!</p>	3	Laboratoires Arcopharma	R	2014



		<p>Suite à la conversation téléphonique en date du <b>02/12/2013</b> avec M<sup>me</sup> <b>Elisabet Carlos</b>, l'Office confirme, par la présente, la décision que vous avez prise, en vue de vous conformer à la règle 9, paragraphe 3, du REMC, de modifier la description de la marque, ainsi que le type de marque. La description de la marque est désormais la suivante: « <b>La marque consiste en un hologramme composée du text "PLANTE SYSTEM FRANCE" et 4 cercles, en relief argent sur papier holographique violet avec reflets à l'horizontale</b> » et le type de marque a été modifié pour passer de marque «figurative» à marque «<b>hologramme</b>».</p> <p>L'Office va maintenant poursuivre l'examen de la demande.</p> <p><b>Bruno Laurent GUERRA</b></p>				
EM	17579491	 <p>The image is a screenshot of a video player. The video frame shows a white rectangular card with the text "LET THE ARGONAS DRAIN DOWN" in a serif font. Below the text is a red, rectangular object with two horizontal lines extending from its sides, resembling a stylized container or a piece of equipment. The video player interface includes a progress bar at the bottom and a browser address bar at the top.</p>	16, 21 35	Zwilling J.A. Henkels	R	2018

EM	17993401		9	Google LLC	R	2019
EM	18101015		5 16 35	Bionorica	R	2019
FR	1 525 074	 <p data-bbox="555 1230 1447 1370">L'hologramme est constitué de rectangles successivement bleu et vert sous incidence perpendiculaire. Sous les autres angles d'incidence, les couleurs varient selon la loi <math>\lambda \cos i</math> où <math>\lambda</math> est la longueur d'onde de la lumière et <math>i</math> l'angle d'incidence (en radians).</p>	9 16 36	GROUPEMENT DES CARTES BANCAIRES	R	1989



FR	96 637894	 <p>Marque comportant un hologramme Mark comprising a hologram Hologrammenthaltende Marke</p>	9 16 36 38	GROUPEMENT DES CARTES BANCAIRES	R	1996
FR	96657860	 <p>Marque comportant un hologramme. Mark comprising a hologram</p>	3 24 25	Nitya sarl	R	1996
FR	99768498	 <p>Trademark consisting of a hologram</p>	25	Granereau	R	1999
FR	003072825	 <p>Marque déposée en couleurs; marque comportant un hologramme Mark filed in colour; mark comprising a hologram.</p>	29 30 31	Generale traiteur	R	2000

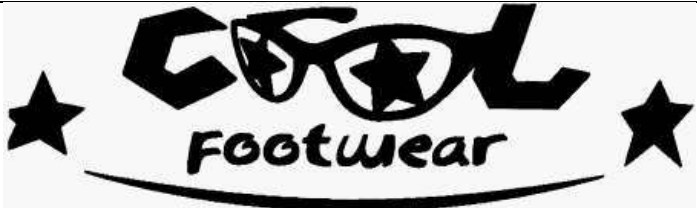

FR	013087664	 <p>Square made up of light pink and dark pink sections within a yellow frame made up of small suns, the trademark comprising a hologram. Carré fait de roses claires et roses foncées entouré d'un cadre jaune fait de petits soleils, la marque comportant un hologramme.</p>	25	Elise Aucourtuier	R	2001
FR	033220578	 <p>La marque comporte un hologramme. The trademark comprises a hologram.</p>	10	Alfred Pfennig	R	2003
FR	033247255	 <p>Mark comprising a hologram representing spectacles in the place of "OO"</p>	25	Granerreau	R	2003



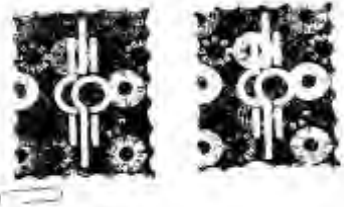







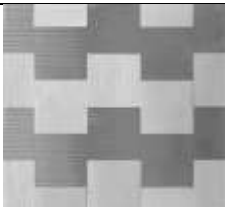

FR	033259798	 <p data-bbox="555 375 1438 443">Logo consisting of spectacles followed by the term "FOOTWEAR"; trademark comprising a hologram</p>	25	Granerreau	R	2003
FR	053346093	 <p data-bbox="555 710 1456 815">Mark comprising a hologram; the vignettted green is the background colour; the logo in the shape of a gilded pear; the strip border in the form of a rectangular chain in gold.</p>	16 21 24 30	D et S Sarl	R	2005
FR	053386430	 <p data-bbox="725 1082 1265 1112">Mark comprising a hologram - "NOT SLAVE".</p>	16 25 38	LE RIDOU BONNAUDEAU Frédéric	R	2005



FR	063445514	 <p>The trademark KOODBULL is a semi-figurative mark comprising a hologram reproducing a head butt; the principal colours are blue, white and red</p>	25 28	Said Bouhmama	R	2007
FR	073477283	 <p>Description de la marque : Nom de marque : " KOOD BULL " avec la première lettre " K " inversée. Slogan : " For respect ". Prononciation : " KOUD"BOUL ", KOOD BULL the letter K being written nversed</p>	16 25 28 35	Said Bouhmama	R	2007
FR	12 3 886 579	 <p>Trademark comprising a hologram. Marque comportant un hologramme</p>	3 14 18 24 25	Melle MANENTI Dominique	R	2012





GB	2031496		36	Checkpoint Security Services	W	2000
GB	3059420		37 39 43 44	O2 Worldwide	R	2014
GB	3189612	 <p data-bbox="555 1273 1458 1372">The mark is a moving image consisting of a single (non - variable) animated visual sequence of movement comprising 9 images in the complete sequence as depicted in the</p>	43	Marston's PLC	R	2017

		<p>stills set out in the application and numbered 1 - 9 which also show the sequential order where the sequence begins (as shown at image 1) and changes to the same image with a horizontal "i" (image 2) followed by the previous image plus the letter "z" (as shown in image 3) followed by the previous image plus an additional letter "z" (as shown in image 4) followed by the previous image plus a letter "s" (as shown in image 5) and then goes into reverse with the removal of the letter "s" (as shown in image 6) and the removal of the top letter "z" (as shown in image 7) and the removal of the other letter "z" (as shown in image 8) and finally the removal of the horizontal letter "i" (as shown in image 9) returns to the original (image 1) starting point. Sequence lasts 6 seconds.</p>				
GB	3375918		9	Google	R	2019
HU	154630		3 10 21	SmithKline Beecham p.l.c	R C	1999 2009
HU	241177	See mp4 file	33	Egri Bovidek ..	R	2023

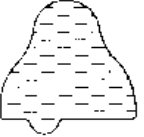
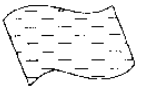
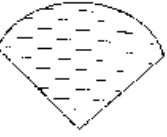

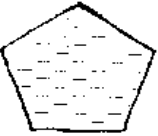
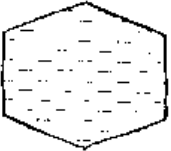

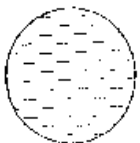
IT	2019074951		9 25 28	Giancollo piero	R	2020
IT	2020062293	OASIWELL BMAXWELL	16 29 30	C Antonello	R	2022
IT	2022085118	EmmeÉlle	6	Crezenso Guiseppe	R	2023
NO	241356		9	SEAHAWK Navigation AS	R	2007
RU	464689	TOYOTA GT 68	12	TOYOTA	R	2012
RU	465168	CHROMEBOOK	9 35 42	Google Inc	R	2013
RU	489400		11 17	Elite Strategical Union	R	2013
RU	515266	??	17	??	R	2014
RU	518741	??	29	??	R	2010
RU	601358		29	??	R	2010
RU	754393		3 35	??	R	2020
RU	828086		32	??	R	2020

SE	1997/01171	 <p>Hologram formed by a kaleidoskop varying picture depending on the light</p>	3 10 21	SmithKline Beecham p.l.c	E	2007
SG	T0108194C	 <p>The mark consists of a simple hologram as shown in the representation attached to the application form.</p>	03	Nitya sarl	E	2002
SG	T0108195C	 <p>The mark consists of a simple hologram as shown in the representation attached to the application form.</p>	24	Nitya sarl	E	2002
SG	T0108196C	 <p>The mark consists of a simple hologram as shown in the representation attached to the application form.</p>	25	Nitya sarl	E	2002

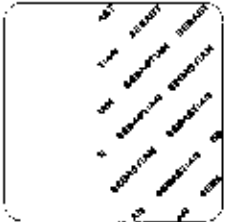

SG	T0318748C	 <p>Seen from the top to bottom: color changes: the writing of the trademark logo turns blue except for the dash and the underline (the word „balance“ written in green turns blue, the red dash stays red, the yellow line under „head“ stays yellow)</p>	10	Alfred Pfennig	E W	2004
US	2143827		16	Rembrand Photo services	R	1997
US	2165006		16	Upper Deck Company	R W	2005
US	2165007		16	Upper Deck Company	R W	2005
US	2165008		16	Upper Deck Company	R W	2005



US	2177761		16	Upper Deck Company	R W	2005
US	2177762		16	Upper Deck Company	R W	2005
US	2177763		16	Upper Deck Company	R W	2005
US	2179830		16	Upper Deck Company	R W	2005
US	2278307	 <b>Aquafresh Whitening ... Gel</b>	3	SmithKline Beecham	R	1999

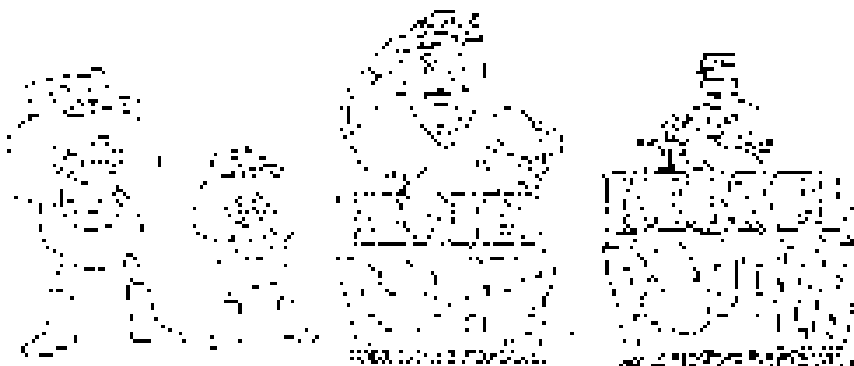
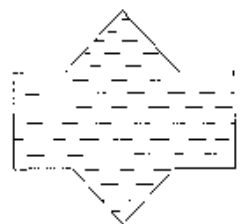

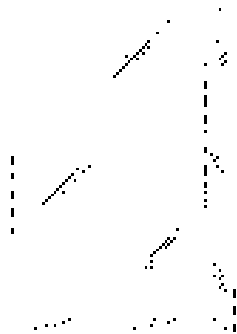

US	2288159		Kollektiv marke	Sebastian International	R	1999
US	2324607	 <b>Aquafresh Whitening ...</b>	3	SmithKline Beecham	R	2000
US	2324617	 <b>Whitening ...</b> <b>Aquafresh</b>	3	SmithKline Beecham	R	2000
US	2360979		16	Upper Deck Company	R	2000
US	2619227		16 28	Upper Deck Company	R	2003

US	76/388825	 <p>The mark depicting popped popcorn in a three-dimensional arrangement; three popped popcorn cartoon characters that move from the foreground to the background depending upon the angle one views the image; a cartoon man dressed in a military costume that changes into a popcorn cartoon character dressed in a military costume depending upon the angle that one views the box above the words "THE KERNEL POPPER MICROWAVE POPCORN".</p>	30	Kernel Vendors	E	2005
US	2710652		16	Upper Deck Company	R	2003

US	2730207	 <p>The mark consists of holographic paper that reflects a spectrum of color in a pattern of oblique, parallel lines. The dotted lines and lining shown in the drawing form no part of the mark, and are for shading or other illustrative purposes only.</p>	34	Eve Holding Corp.	R	2004
US	2910381	 <p>TESSUTO FILODISCOZIA ALTA QUALITA FABRIC MADE IN ITALY</p> <p>The mark consists of stylized wording, a graphic design and a hologram. The graphic symbol comprises a square that contains a central square and is characterized by fanciful half moons that represent fabric in the process of weaving with curved lines converging toward the center from all four sides, such lines representing the yarns; the elements forming the symbol are presented in alternating colors of dark moss, dove gray and pale dove gray; beneath the symbol appears the wording 'TESSUTO FILO DI SCOZIA ALTA QUALITA' in fanciful arrangement with the initial letter "S" of the word "SCOZIA" more dominant and placed in a central position, beneath which is the wording "FABRIC MADE IN ITALY" in gold block letters; below the</p>	25	Produttori ..	R	2004

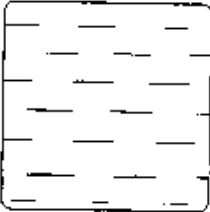
		wording appears a circular hologram characterized by a tridimensional effect with the wording "MADE IN ITALY" in block capital letters superimposed over a representation of the graphic symbol yarn logo displayed at the top of the label, the entirety of the design being arranged on the substantially rectangular background with rounded corners having a narrow pale dove gray border, the interior of the rectangle comprising a geometric fantasy background consisting of vertical, horizontal and diagonal lines of pale gray color with pale yellow background and the border wording commencing clockwise CERTIFICATE OF GURANTEE, GARANTIEZERTIFIKAT, CERTIFICAT DE GARANTIE, CERTIFICADO DE GARANTIA, Chinese meaning Certificate of Guarantee and GARANTIEBEWIJS				
US	2497918	 <p>The mark consists of a hologram which contains the words FAIR &amp; WHITE HEALTH SECURITY LABO DERMA PARIS.</p>	3	Tancogne, Xavier France	E R	2005
US	75/731306	 <p>The mark consists a checkerboard pattern of uniformly sized silver squares on metallized film that reflect light, thereby creating a hologram design of repeating polygons consisting of various combinations of squares, hexagons, and triangles.</p>	3	Reckit & Colman	E W	2000

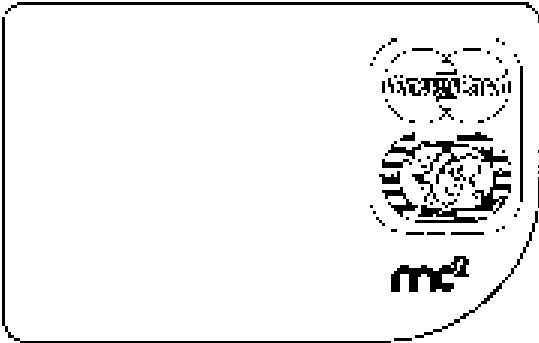

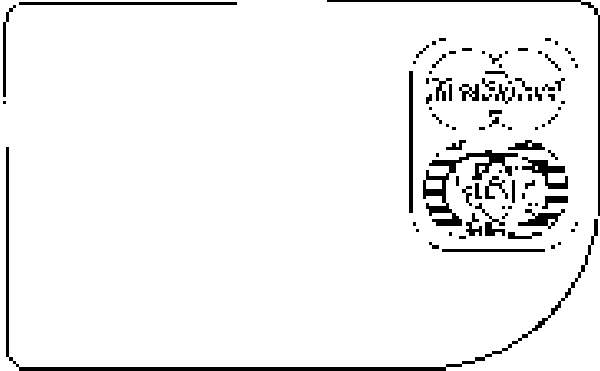
US	76/439201		16	Upper Deck Company	E W	2004
US	76671001	 <p data-bbox="555 699 1406 778">iridescent with a silvery overtone. The mark has a <b>hologram</b> feature and the color claimed is iridescent with a silvery overtone</p>	09	Sony DEricson	E W	2007
US	78/122893	 <p data-bbox="555 1185 1447 1364">The mark consists of a distinctive card shape design comprising a rounded lower right corner. The right portion of the card shape design features a holographic device comprising the word MASTERCARD in outline form superimposed across a device comprising two interlocking circles. Positioned directly under the MASTERCARD design is a holographic device comprising a map of the</p>	9 36	MASTERCARD International	E W	2007

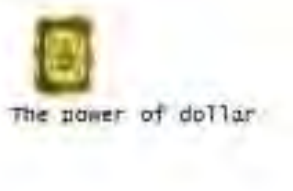
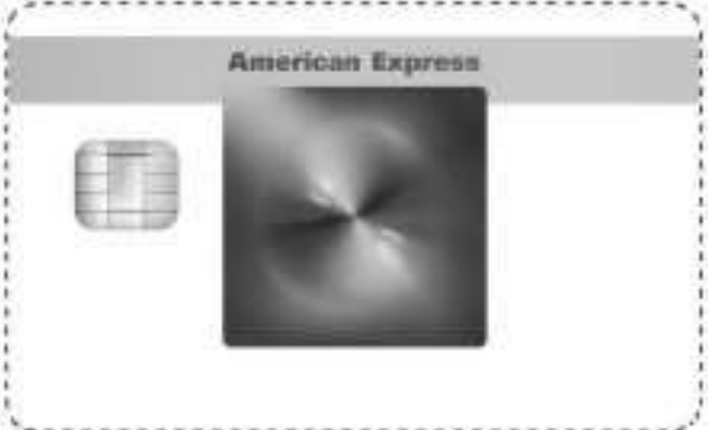

		world within two interlocking globes. Please note that the design comprises a drawing of an actual <b>hologram</b> . For security purposes, the MASTERCARD word will not reproduce exactly as embedded within the <b>hologram</b> . The word MASTERCARD photographs as MasterCard and Card Master within the <b>hologram</b> design. A retaining line surrounds both of these design elements. Beneath the holographic device appears the term MC2 appears in the bottom right hand corner of the distinctive card shape..				
US	78/122910	 <p style="text-align: center;">Mastercard</p> <p>The mark consists of a distinctive card shape design comprising a rounded lower right corner. The right portion of the card shape design features a holographic device comprising the word MASTERCARD in outline form superimposed across a device comprising two interlocking circles. Positioned directly under the MASTERCARD design is a holographic device comprising a map of the world within two interlocking globes. Please note that the design comprises a drawing of an actual hologram. For security purposes, the MASTERCARD word will not reproduce exactly as embedded within the hologram. The word MASTERCARD photographs as MasterCard and Card Master within the hologram design. A retaining line surrounds both of these design elements.</p>	9 36	MASTERCARD International	E W	2007

<p>US</p>	<p>78/388126</p>	 <p>The mark consists of Hologram with gold trim design [background], green trim overlay design and dollar sign, gray [dollar]bill insert.</p>	<p>36</p>	<p>Powerdollar</p>	<p>E W</p>	<p>2005</p>
<p>US</p>	<p>3045251</p>	 <p>The mark consists in part of a hologram image in the center of the mark. The stippling is a feature of the mark.</p>	<p>36</p>	<p>American Express</p>	<p>E R</p>	<p>2006</p>

US	3023854	 <p>Mark comprising a hologram representing spectacles in the place of "OO"</p>	25	Granerreau	E R	2005
US	3015771	 <p>Logo consisting of spectacles followed by the term "FOOTWEAR"; trademark comprising a hologram</p>	25	Granerreau	E R	2005
US	3356528	 <p>The color(s) YELLOW, LIGHT PINK, DARK PINK, and BLACK is/are claimed as a feature of the mark." . Square logo consisting of a light pink and dark pink combination; yellow frame of the logo. "The mark consists of of a square design consisting of a LIGHT PINK and DARK PINK combination and the design is framed in YELLOW. The square is made up of LIGHT PINK and DARK PINK sections within a YELLOW frame made up of small sun designs. The stylized ÉLISE AUCOUTURIER LINGERIE wording is in BLACK</p>	25	ELISE AUCOUTURIER	R	2007







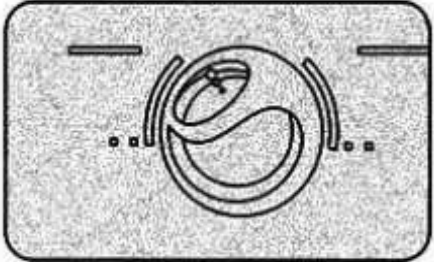
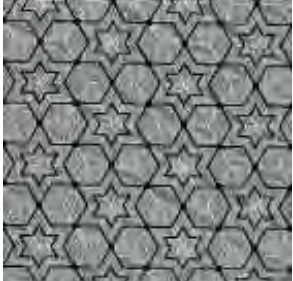

US	3407662	 <p>The color(s) green, purple, orange, yellow, blue and silver is/are claimed as a feature of the mark. The mark consists of a shield in the form of a <b>hologram</b>, the wording/letters appear from left to right in green, purple, orange, yellow, blue and silver. The background of the shield is in silver.</p>	16	McCaffery & Associates	R	2008
US	76671000	 <p>The stippling in the mark represents a <b>hologram</b> with iridescent effect superimposed on the wording and design elements</p>	9	Sony Ericsson	E W	2007
US	77006890	 <p>Color is not claimed as a feature of the mark. The mark consists of squares in a diamond pattern enclosed by a circle with the wording "smart <b>holograms</b>" below the circle.</p>	1 5 9 10 16	Smart Holograms Ltd	E W	2008

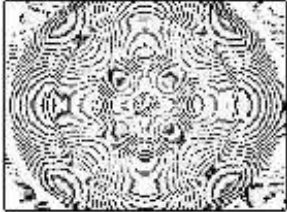

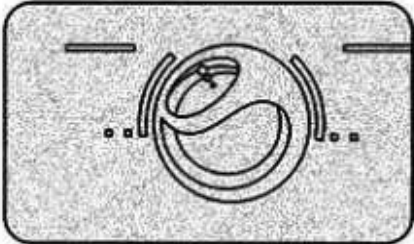
US	77185971	 <p>Color is not claimed as a feature of the mark. The mark consists of squares in a diamond pattern enclosed by a circle, wherein the squares are shown in two different shades in an arrangement to display a S representation in the middle, with the wording "smart <b>holograms</b>" below the circle.</p>	1 5 9 10 16	Smart Holograms ltd	E W	2008
US	77252286	 <p>The color(s) Gold, green, orange, bronze and red is/are claimed as a feature of the mark. The mark consists of a reflective <b>hologram</b> with a gold background with circles in shades of green, orange and bronze and the word "GLAMOURAZZI" in red.</p>	3	Beauty Bank Inc.	E W	2009
US	3487574	 <p>The color(s) Blue, Navy Blue, Silver is/are claimed as a feature of the mark. The mark consists of Computer Wizard with hologram futuristic screen and computer with double keyboard typing</p>	35	Fernando Robles	E R	2008

US	77289827	 <p>The color(s) Blue, Navy Blue, Silver is/are claimed as a feature of the mark. The mark consists of Computer Wizard with hologram futuristic screen and computer with double keyboard typing</p>	42	Fernando Robles	E W	2008
US	3628131	 <p>Color is not claimed as a feature of the mark. The mark consists of design elements and a <b>hologram</b>. The stippling in the mark represents a <b>hologram</b> with iridescent effect superimposed on the design elements</p>	9	Sony Ericsson Mobile Communications AB Corporation	E R <b>W</b> <b>2016</b>	2009
US	3888210	 <p>The mark consists of hexagonal or beehive main patterns with occasional six-pointed stars spread in an alternate mode. Other six-pointed small stars are placed within the occasional stars. Each nodal point of the patterns is thick-dotted. Another set of hexagonal or beehive shade patterns are spread in multi-lined hatching mode and overlapped in contract to the main patterns. The shade patterns are crossed over with the main patterns such that the main patterns also forms cubic <b>hologram</b> images.</p>	18	VL & CO Corporation CORPORATION REPUBLIC OF KOREA	E R <b>W</b> <b>2017</b>	2010

US	3747810	 <p>The color(s) black, gold, orange, red, yellow, green, blue, indigo, white, beige and violet is/are claimed as a feature of the mark. The mark consists of a horizontal black rectangle containing the words "MAHMOOD TEA" in white, at the top of the drawing. Three vertical rectangles appear below the black rectangle, the outer two of which are beige in color and the inner rectangle is gold on the top portion and orange towards the bottom. In the center of the drawing is a diamond shaped design with the letter "M" in gold on a black background and a translucent border. A cup of tea in a glass mug appears superimposed over the bottom half of the gold letter "M." A thin horizontal gold rectangle appears below the center design near the bottom of the drawing and flows across the three vertical rectangles. A circle design in gold and black appears towards the upper right hand corner of the beige vertical rectangle with the wording ALTUNKAYA GROUP OF COMPANIES in black, which wraps around the border of this design. A picture of a building in black and gold appears in the center of the circle design. Below this design in the bottom right corner of the beige vertical rectangle is a square with the colors red, orange, yellow green, blue, indigo and violet appearing in rainbow form in a hologram design element with the identical circle design described above, however, the design and wording is in white. The words MAHMOOD TEA appears above the circle design in white, also within the hologram design element.</p>	30	Altunkaya Insaat Nakliyat Gida Ticaret Anonim Sirketi	E R	2010
----	---------	--	----	---	-----	------



US	78909404	 <p>The mark consists of a hologram of concentric circles applied to the packaging.</p>	28	Nike Inc.	E W	2007
US	79018732	 <p>Mark comprising a hologram; the vignettted green is the background colour; the logo in the shape of a gilded pear; the strip border in the form of a rectangular chain in gold.</p>	16 21 24 30 32	D et S S.a.r.l	E W	2006
US	3628131	 <p>The mark consists of design elements and a hologram. The stippling in the mark represents a hologram with iridescent effect superimposed on the design elements</p>	9	Sony Ericcson	R	2010

US	3737020	 <p>The trademark KOODBULL is a semi-figurative mark comprising a hologram reproducing a head butt; the principal colours are blue, white and red; green, white and red; the trademark is available in several versions in addition to the principal colours of the initial filing, in particular in green-yellow-red etc.</p>	25 28	BOUHAMA SAID UNKNOWN	E R	2010
US	3654876	 <p>Color is not claimed as a feature of the mark. Mark comprising a hologram - "NOT SLAVE".</p>	16 25 38	LE RIDOU BONNAUDEAU Frédéric	E R	2009
US	3888210	 <p>The mark consists of hexagonal or beehive main patterns with occasional six-pointed stars spread in an alternate mode. Other six-pointed small stars are placed within the occasional stars. Each nodal point of the</p>	18	VL & CO Corporation	R	2010

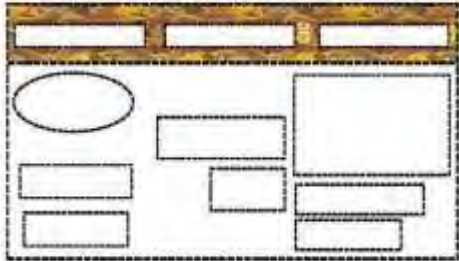



		patterns is thick-dotted. Another set of hexagonal or beehive shade patterns are spread in multi-lined hatching mode and overlapped in contract to the main patterns. The shade patterns are crossed over with the main patterns such that the main patterns also forms cubic hologram images				
US	4189051	 <p>The color(s) gray and silver is/are claimed as a feature of the mark. The mark consists of gray and silver numbers "0" and "1" to form a geometric rectangular shape with gray and silver letters "A U T H", the overall mark impression is a holographic hologram. The color white represents the background</p>	42	Interactive corp.	R	2012
US	5043722	 <p>The mark consists of an overall square design comprised of three rows of geometric shapes with gray shading. From left to right, the top row is comprised of three squares with rounded corners. The left most square has a white background and features a close-up of a silver metallic tool with shading. The center square has a white background and features two gray jugs with black cap and white stickers with illegible black writing and a red design atop a horizontal black surface with a white cylindrical tube with black writing and design thereon and black lining and holes on the end. The right square has a white background with a silver metallic machine part with a brown recessed cavity in front of a brown box with the wording</p>	8 9 16 35	Deutz AG	R	2016

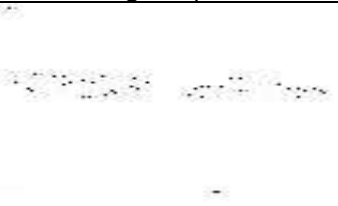
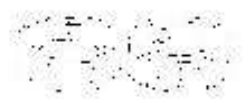

		<p>"UTZXCHANGE" stylized font on the left side of the fold and "DEUTZ" on the right side of the fold. "UTZ" and "DEUTZ" are in black and "XCHANGE" and "X" are in red. From left to right, the middle row has a gray horizontal rectangle with rounded corners featuring the words "DEUTZ SERVICE LIFE TIME SUPPORT" in black stylized font. The right square has rounded corners, a white background with a pink man with brown hair and eyebrows wearing a white shirt and black jacket pointing at a two-dimensional <b>hologram</b> of the Earth with water represented in blue and land in dark blue with intersecting white lines and curves scattered thereon. The bottom row is comprised of three squares with rounded corners. From left to right, the left most square has a white background and silver metallic piping with copper highlighting. The middle square has a white and gray background and white and light blue foreground with a gray and black metallic engine and red base to the upper left of a gray Greek cross on a dark gray circle design circumscribed by a gray circular band. The left square has a white, beige and green background with the beige appearing to be a wall and the white portion a frame of a door through which a window displays green grass. A black computer monitor frame displays a white background with indecipherable black and red images and text with gray outlining. The bottom left side of the computer monitor has a pink rectangular note attached thereto and is displayed above a white desk with white and silver computer peripheral, keyboard, and mouse. Two pink hands are operating the keyboard and mouse, respectively. A white, black, and gray object is next to a white tube to the right of the operator's hands. The blurred red, white, and gray plaid design of clothing is visible in the lower right corner of the square</p>				
US	5456238	 <p>The mark consists of a <b>hologram</b> featuring a repeating pattern of circles, circles with laurel wreaths, the letters "CIC", the letters "OK", and wavy lines, all in the color gold. The pattern appears at the top of the coupons, and the broken lines indicate the mark's placement on the goods.</p>	16	Coupon Information Corp.	R	2018





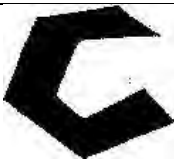

<p>US</p>	<p>5538324</p>	 <p>The mark consists of a rectangle split horizontally, with the top half on a brown background, with the stylized wording "RIAS BAIXAS DENOMINACION DE ORIGEN" in green on the left. On the right, a stylized dark brown drawing of the northwest coastline of Spain appears outlined in green. Within the coastline, a green map of Spain appears with a red dot on the map. The bottom half of the split rectangle is on a green background, with the stylized wording "GALICIA" in brown, "ESP" in red, and "CONSEJO REGULADOR" in brown. Two brown vertical lines appear on each side of "ESP". A white rectangle design representing the location of a <b>hologram</b> appears on the right side of the green background, containing the repeated wording "RIAS BAIXAS DENOMINACION DE ORIGEN" in light green, blue, red, orange, and purple. A gray rectangular shape and the gray wording "CONSEJO REGULADOR", "GALICIA", and "ESP" appearing between two gray vertical lines are part of the <b>hologram</b>.</p>	<p>33 Certification Mark</p>	<p>CONSEJO REGULADOR DENOMINACION DE ORIGENRIAS BAIXAS CORPORATION SPAIN</p>	<p>R</p>	<p>2018</p>
<p>US</p>	<p>85130702</p>	 <p>The mark consists of The mark consists of three-dimensional design features of a wristband or bracelet comprising two non-functional horizontally-oriented rectangular shapes positioned 180 degrees opposite one another and two non-functional curved lines. Each line is positioned in the middle of the wristband or bracelet and runs around part of the exterior circumference of the goods and is placed 180 degrees opposite the other line. Each line is positioned between the rectangular shapes but does not extend to touch the side edges of the rectangular shapes. Circular holograms are also positioned on the interior portion of the</p>	<p>14 25</p>	<p>EFX Performance Inc</p>	<p>E W</p>	<p>2012</p>



		rectangular blocks. The matter appearing in dotted lines is not part of the mark and serves only to show the position of the mark on the goods.				
US	85130715	 <p>The mark consists of Non-Functional oval in center of the product with double non-functional colored lines extending around the circumference of the product with a <b>hologram</b> positioned on the back of the oval</p>	14	EFX Performance Inc	E W	2012
US	85130723	 <p>The mark consists of Non-functioal oval positioned in the center of the product with a single colored line around the circumference of the oval and additional single colored lines extending around the circumference of the product on both the inside and the outside of product and one <b>hologram</b> positioned on the interior of the oval.</p>	1254 25	EFX Performance Inc	E W	2012
US	85130733		14 25	EFX Performance Inc	E W	2012

		The mark consists of Non-functional oblong shaped badges mounted 180 degrees opposite one another on the product, which each badges contains one <b>hologram</b> positioned on the right side of the badge and such <b>hologram</b> is encased by a single non-functional colored line around its circumference.				
US	4378225	 <p>Color is not claimed as a feature of the mark. Trademark comprising a hologram by request of Examiner <u>changed to</u> The mark consists of the wording "SECRET SPIRIT" and the design of a bird, namely, a hummingbird.</p>	3 14 18 24 25	Melle MANENTI Dominique	E R	2013
WO	545211	 <p>L'hologramme est constitué de rectangles successivement bleu et vert sous incidence perpendiculaire. Sous les autres angles d'incidence, les couleurs varient selon la loi <math>\lambda \cos i</math> où <math>\lambda</math> est la longueur d'onde de la lumière et <math>i</math> l'angle d'incidence (en radians)., bleu et vert</p>	9 16 36	GROUPEMENT DES CARTES BANCAIRES	R	1989
WO	683249	 <p>Marque comportant un hologramme</p>	9 16 36 38	GROUPEMENT DES CARTES BANCAIRES	R	1997
WO	695878	 <p>Mark consisting of a hologram.</p>	3 24 25	NitYa	R	1998

WO	766623		29 30 31	Generale Traiteur	R	2001
		Mark filed in colour; mark comprising a hologram.				
WO	775608		25	Granereau	R	2002
		Trademark consisting of a hologram				
WO	812689		10	Alfred Pfennig	R	2003
		The trademark comprises a hologram				
WO	820025		25	Granerreau	R	2004
		Mark comprising a hologram representing spectacles in the place of "OO"				

WO	825418	 <p>Logo consisting of spectacles followed by the term "FOOTWEAR"; trademark comprising a hologram</p>	25	Granerreau	R	2004
WO	871099	 <p>Mark comprising a hologram; the vignetted green is the background colour; the logo in the shape of a gilded pear; the strip border in the form of a rectangular chain in gold.</p>	16 21 24 30	D et S Sarl	R	2006

<p>WO</p>	<p>888562</p>	 <p>ÉLISE AUCCOUTZRIER</p> <p><i>Lingerie</i></p> <p>Square made up of light pink and dark pink sections within a yellow frame made up of small suns, the trademark comprising a hologram. Carré fait de roses claires et roses foncées entouré d'un cadre jaune fait de petits soleils, la marque comportant un hologramme.</p>	<p>25</p>	<p>Elise Aucoutzrier</p>	<p>R</p>	<p>2006</p>
<p>WO</p>	<p>932309</p>	 <p>The colour blue extends from above the head of the hologram to the left foot and outlines the curve of the left leg;</p>	<p>25 28</p>	<p>BOUHMAAMA SAID UNKNOWN FRANCE</p>	<p>R</p>	<p>2007</p>

		the colour red extends from above the head of the hologram to the right foot and outlines the curve of the right leg.				
WO	961381	 <p>Mark comprising a hologram - "NOT SLAVE".</p>	16 25 38	LE RIDOU BONNAUDEAU Frédéric	R	2008
WO	1133960	 <p>Trademark comprising a hologram Marque comportant un hologramme</p>	3 14 18 24 25	Melle MANENTI Dominique	R	2012

\*

W = zurückgezogen oder zurückgewiesen, withdrawn or rejected

R = eingetragen, registered

E = geprüft, examination

A = Beschwerde, Appeal

O = im Widerspruch, opposition