



















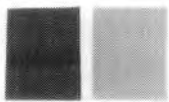

Farbmarken / Color Marks





Land Country	Aktenz. Serial#	Marke Mark	Klasse Class	Anmelder Applicant	Status *	Check / Status
AE	80022	Pantone 21C (orange)	30	Mars Corp.	R	2007
AT	52977		30	Kraft Foods Schweiz Holding GmbH	R	1964
AT	178911		16 41	Manz'sche Verlags- und Universitätsbuchhandlung GmbH	R	1998
AT	204067		30	Joseph Manner & Comp	R	2002
AT	230825	 Gentian blue RAL 5010 and yellow-green RAL 6018 Secondary Meaning verkehrsdurchgesetzt	4 35 36 37 39 43	OMV Aktiengesellschaft	R	2006
AT	236314	 rot / red	6 7 20	Hilti AG	R	2007
AU		Terracotta applied on polypipe fittings	19	Philmac Pty Ltd	R	
AU	559837	Green / grün	4 37	BP plc	E O	2005
AU	661706	Light blue / hellblau	11	Alfa laval agri Pty Ltd	R	1998
AU	700016	Blue / blau	19	Carter hold harvey	R	1997
AU	704779	Orange for labels on sparkling wine	33	Veuve Clicquot	R	1999



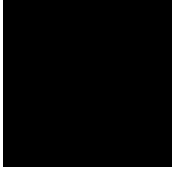

						
AU	710226	Silver / silber	29	Kraft Foods Ltd	R	2000
AU	711142	Yellow / gelb	39	Yellow cabs (Queensland)	R	1999
AU	749403	 THREE HORIZONTAL STRIPES, ORANGE, GREEN & RED	35	7-Eleven, Inc	R	2000
AU	750445	 Maroon	9	Trojan Battery Company	R	2002
AU	751852	Gelb / Yellow	1 9 16 35 40	Kodak (Australia) Pty	R	2002
AU	762245	Gelb / schwarz Gelb / schwarz	12	Luk Lamellen und Kupplungsbau Beteiligungs AG	R	2003
AU	763168	purple	3	3M Australia Pty	R	2003
AU	771390	 Purple	30	Kraft foods Schweiz Holding	R	2005
AU	773448	Yellow / gelb	39	Australian Postal Corp.	R	2001
AU	773449	Red / white	39	Australian Postal Corp	R	2001
AU	773450	Red	39	Australian Postal Corp	R	2001
AU	773693	orange	5	Pfizer Inc.	R	2002







AU	780092	 Blau / blue	6 9 20 39	Brambles Australia Limited	R	2001
AU	795001	 Orange (pantone 151)	35 37 38	Orange Personal Communications Ltd	R	2002
AU	796572	Terracotta (PMS 484c + /- 10% Lab, when observed under a controlled D65 illuminant) 	17	Philmac Pty Ltd	R	2003
AU	820449		35 37 38	Orange Personal Communications Ltd	R	2000
AU	888415	 The trade mark consists of the colour GREEN as shown on the example attached to the application form	30	Nestle	R	2001
AU	898187	 The color YELLOW (PANTONE 123)	5	Schering Plough	R	2005





AU	909518	 The color Green	1 4 37	BP plc	R O W	2004
AU	922022	 Blue and silver stripes	32	Red Bull GmbH	R	2005
AU	924454	Blue / blau	14 21	Wedgwood ltd	R	2005
AU	926016	Yellow pantone 012	6 17 35 37	Hydraulink Fluid connectors	E W	2005
AU	932937	The color purple (CMYK: cyan 40%, magenta 100%)	31	Effem Foods ply	E O	2008
AU	942370	 RHODANINE: 45%, RUBY RED: 27%, RAPIDA BLACK: 28%	16 21 32 33	Laurent-Perrier	E W	2004
AU	953781	Turquoise	3	Henkel KGaA	E W	2004
AU	976935	Pink (pantone 241)	3	Henkel KGaA	E W	2005
AU	980086	 the colour BLUE as shown in the attached representation, which is applied to the entire surface of the goods	6	One Steel Wire Pty Ltd	R	2007
AU	999973	 colour YELLOW (specifically identified as PMS 116) applied to packaging and advertising materials for fresh fruits and vegetables	16 31	Zespi Group Ltd	E W	2006





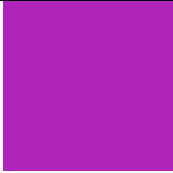

AU	999982	 GREEN (specifically identified as a unique colour made from PMS yellow (34.8%), PMS green (12.1%), PMS white (51.6%) and PMS black (1.5%), applied to packaging and advertising materials for fresh fruits and vegetables	16 31	Zespi Group Ltd	E W	2006
AU	999983	 the colours RED (specifically identified as PMS 032) and YELLOW (specifically identified as PMS 116), applied to packaging and advertising materials for fresh kiwi fruit	16 31	Zespi Group Ltd	R	2006
AU	1020343	silver	16	Henkel France	E W	2006
AU	1037211	The trademark consists of three stripes in the colors ORANGE (pantone 165), BLUE (pantone 281) and WHITE, which may vary in thickness and which trail off the page	35 36	Ing groep N.V.	E W	2006
AU	1041058	The trade mark consists of a combination of the colours ORANGE and GREY as depicted in the representations	17 20 21	Gardena Manufacturing	R	2006
AU	1067033	The mark comprises a shade of the colour BLUE, Pantone 296C	7	Somfy	E W	2006
AU	1067752	 Dulux colour 'MAGENTA BASE' (no added tinter), base/colour no.: 88075, HOT PINK MAGENTA	44	Dashing Hounds Holding Pty Ltd	E W	2007
AU	1082469	 GREEN as determined by RAL 150 60 40.; Parts Colour Claimed: The colour GREEN as determined by RAL 150 60 40	19	Aquatherm GmbH	E W	2007
AU	1095977	 The trade mark comprises the colour RED applied to laminated veneer lumber	19	Carter Hold Harvey Wood Products Pty Ltd	E W	2007





AU	1097418	 the mark consists of the colour YELLOW, as shown in the representations attached to the application, applied to or in relation to the specified goods and the specified services; the colour is exemplified by the following colours in the Pantone Matching System: PMS 109C (for coated stock) and PMS 108U (for uncoated stock)	16 35	Telstra Corp. Ltd.	E	2008
AU	1106827	 colour BLACK as depicted in the representation attached to the application form, is applied to the whole surface of the goods.	16	RENOVA	E	2008
AU	1114591	 colour is COPPER	12	Concept Caravans Pty	E	2008
AU	1116508	 colour BLUE, as shown in the attached representation and identified as Pantone Matching System (PMS) 660	6 35	Bluescope Steel Ltd	E	2008
AU	1120614	 colour PURPLE depicted in the representation attached to the application form being approximated by reference PMS 2685C in the Pantone Colour Formula Guide and used in relation to the designated goods	30	Cadbury Ltd	E O	2008

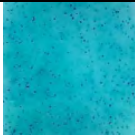



AU	1120615	 colour PURPLE depicted in the representation attached to the application form (PMS 2685, which has an LAB value of L=33.07, A=34.13, B=-43.07, all such values +/- 10%) used in relation to the designated goods	30	Cadbury Ltd	E O	2008
AU	1120617	 colour PURPLE depicted in the representation attached to the application form being approximated by reference PMS 2685C in the Pantone Colour Formula Guide	30	Cadbury Ltd	E	2008
AU	1120620	 The trade mark is the colour PURPLE constituted by the spectrum depicted in the representation attached to the application form	30	Cadbury Ltd	E	2008
AU	1120621	 trade mark consists of the colour purple, depicted in the representation attached to the application form being approximated by reference PMS2685C in the Pantone Colour Formula Guide,	30	Cadbury Ltd	E O	2008
AU	1120622	 The trade mark is the colour purple depicted in the representation attached to the application form being approximated by reference PMS 2685C in the Pantone Colour Formula Guide	30	Cadbury Ltd	E	2008



AU	1120623	 trade mark is the colour purple constituted by the spectrum depicted in the representation of the trade mark (PMS 2685, which has an LAB value of L=33.07, A=34.13, B=-43.07, all such values +/- 10%)	30	Cdbury Ltd	E	2008
AU	1130042	 MAGENTA: PANTONE RHODAMINE RED U.	28 32 35 36 41 42	Deutsche Telekom	E W	2008
AU	1140509	 RAL 4006 - VERKEHRSPURPUR (PURPLE	17	Vallourec & Mannenmann Tubes	E	2008
AU	1140871	 The colour Pink PMS 2375	39	Wendy Cato	E	2008
AU	1146098	 colour YELLOW used in connection with anti-corrosion compounds, materials and/or packaging	2 16 17	Northern Technologies International Corp	E	2008
AU	1155199	 Blue	6 9 11 17 19	E. Hawle Armaturenwerke GmbH	E	2008





AU	1174065	 colour RED, specifically identified as PMS 1945, as shown in the representation attached to the application form, applied to signage on and in the premises, printed and visual matter and stationery, packaging and wrapping, promotional, advertising and identification material, for the supply of services	35	Dymocks Holdings PTY Ltd	E	2008
AU	1194047	 colour PINK with Pantone reference number 239C shown in the representation	3	Reckitt Benkiser N.V.	E	2008
AU	1203081	 a colour mark and it consists of the colour YELLOW as a single all-over colour to the surface of the goods	29	Minh Tri Do	E	2008
AU	1212748	 The mark consists of the colour LILAC (Pantone colour PMS2665C), as shown in the representation	17	IRRI POD LTD	E	2008
AU	1212907	 Colour RAL 6026 OPAL GREEN	7	Westfaliasurge GmbH	E	2008
AU	1213710	 The trade mark consists of the colour RED (Pantone 185) used as a background colour for advertising and promotional material	35	JobsJobsJobs Ltd	E	2008



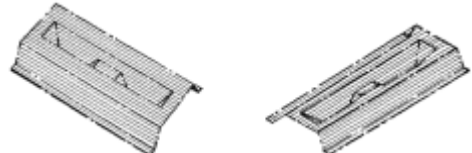
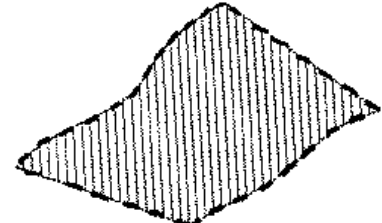

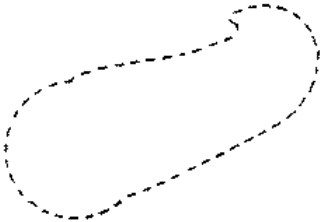
AU	18313848	 PANTONE 151 Pantone 151	30	krikrush basic foods Pty. Ltd.	E	2016
BX	382253		30	Kraft Foods	R	1982
BX	502608	 grün / green	1 4 37	BP	R	1991
BX	543524	 blue / blau	16 36 41 42	Niederlande Finanzministerium	R	1994
BX	551370		3 24 25 27 35	Laura Ashley Manufacturing	R	1994
BX	629097	 <i>Light blue and dark blue.</i>	1 3	Reckitt Benckiser	R	1999
BX	645654		1	Reckitt Benckiser	R	1999



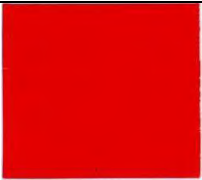

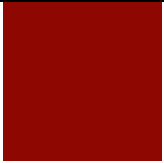
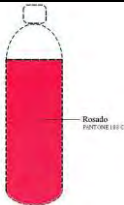

BX	645658		1	Reckit Benckiser	R	1998
BX	645917	 braun	39	UPS	R	1998
BX	667953	 burgunder	30	Unilever	R	2000
BX	692164	 Blau / blue	29	Vandersterre Groep International B.V.	R	2001
BX	697416	 gelb / yellow	30 32	Unilever	R	2001
BX	711202	 Blau /Blue	16 18	Henzo B.V.	R	2002

BX	722741	 Türkis / Turquoise	3	Henkel KG aA	R	2003
BX	722548	 pink (pantone 2419)	3	Henkel KG a.A.	R	2003
BX	754502	 The trademark consists of three stripes in the colors orange (pantone 165), blue (pantone 281) and white, which may vary in thickness and which trail off the page	35 36	Ing Groep N.V.	R	2004
BX	796306	 blau / Blue PMS 2748C	32	Browerijen Alken-Maes N.V.	R	2006
BX	868790	 Magenta (RAL 4010 Telemagenta)	38 42	Deutsche Telekom	R	2009

BX	C104/01 [EuGH] of 06.05.03	 Orange (als Muster angemeldet / applied for as color sample only)	9 35 36 37 38	Libertel Groep BV	A W	2003
BX	915427	 Olivgrün (RAL 6003)	7 8 9	Proxxon S.A.	E A W	2004
BX	915428	 Currygelb (RAL 1027)	7 8 9	Proxxon S.A.,.	E A W	2004
CA	567012	 Two perspectives of the trade-mark are shown in the drawing. The trade-mark consists of the colour pink applied to the whole of the visible surface of the particular attic rafter vent shown in the drawing.		Owens Corning Canada. Inc	R	2002
CA	574625	 The trade-mark consists of the colour pink applied to the whole of the visible surface of the particular sheet of material shown in the drawing.		Owens Corning Canada Inc	R	2003



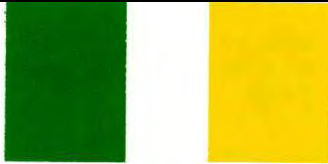

CA	577805	 The trade-mark consists of the colour pink as applied to the whole of the visible surface of the particular slug of polyurethane foam sealant shown in dotted outline in the attached drawing.		Owens Corning Canada Inc.	R	2003
CH	419105	 Lila	30	Kraft Foods	R	1995
CH	464577	 Orange	30	Associated British Foods Plc	R	1996
CH	496219	Yellow Gelb (RAL 1004, Pantone 116 C/109U)	36 39	Die schweizerische Post	R	2002
CH	499949	green (Pantone 347 MC, acquired distinctiveness) / grün (Pantone 347 MC, verkehrsdurchgesetzt)	16	Stämpfli Verlag AG	R	2002
CH	519564	 blue, acquired distinctiveness) / blau, verkehrsdurchgesetzt	3	Beiersdorf AG		
CH	540979	 red / rot RAL 3020	20	Hilti AG	R	2005





CH	555866	 Grey (pantone 5487)/ grau	36	Swiss Re Ltd	R	2005
CH	612176	 zinc-yellow Zink-Gelb (RAL 1018).	7	Alfred Kärcher GmbH & BCo KG	R	2011
CH	693858	 red / rot RAL 3003	8	Victorinox AG	R	2016
CO	544927	Yellow / Gelb PANTONE PMS 100	19	GEORGIA-PACIFIC GYPSUM LLC	R	2016
CO	507282	 Pink pantone 183c	32	GASEOSAS POSADA TOBÓN S.A	R	2014
CO	510204	 Green pantone 361C	30	SOCIÉTÉ DES PRODUITS NESTLÉ S.A.	R	2014
CO	495953	 Yellow	5 29	SOCIÉTÉ DES PRODUITS NESTLÉ S.A.	R	2014

CZ	304707		red / rot pantone 485C	38	Vodafone CZ	R	2009
CZ	316059		magenta RAL 4010 Telemagenta	38 42	Deutsche Telekom	R	2011
CZ	332507		CMYK (Cyan/Magenta/Yellow/K=Black): CO M72 Y11 KO. PANTONE 212C	35 44	Profimed s.r.d.	R	2013
CZ	357967		pantone 225	5	Zentiva k.s.	R	2017
DE	39407183		grün, gelb / green, yellow	7	Deere & Company	R	2000
DE	39407185		grün, gelb / green, yellow	7	Deere & Company	R	2000
DE	39409484		gold, gelb gold, yellow	11	DAL GmbH & Co KG	R	2002



DE	39515536	 saatengrün / seed green	7	Claas KG aA	R	2001
DE	39533891	 ...Gelb (durchgesetzt, aquired distinctiveness)	39	Deutsche Post	R	2003
DE	39541406	 Violett (durchgesetzt, aquired distinctiveness)	5 (Abfüllmassen)	3M Espe AG	R	2000
DE	39545044	 Blau HKS47 100%, weiß (durchgesetzt, acquired distinctiveness)	4	ARAL AG	R	2003
DE	39545083	 .Blau / Blue HKS47 100% (durchgesetzt, acquired distinctiveness)	4	ARAL AG	R	2003
DE	39552629	 magenta, grau / magenta, grey	9 16 37 38 42	Deutsche Telekom AG	R	2001





DE	39552630		magenta (durchgesetzt, acquired distinctiveness)	9 16 37 38 42	Deutsche Telekom AG	R	2000
DE	396128580		Farbe Gelb. Wird Vollfarbe verwendet, so ist das Gelb der standardisierte Farbton HKS 5. Wenn das Gelb aus der Vier-Farben (Euro-)Skala zusammengesetzt wird, wird zu 100 % Gelb 20 % Magenta hinzugefügt	16	Langenscheidt KG	E R	2010
DE	39725801		zitronengelb, silbergrau, anthrazit, tiefschwarz / lemon yellow, silver grey, anthracite, dark black	6 7 9 11 12 17	Wampfler AG	R	2000
DE	39757188		Gelb / schwarz	12	Luk	R	2005
DE	39860754 26W(pat) 26/00		braun (Pantone 4625U)	39	UPS	E A R	2007

DE	39875412	 orange	31 (Saatgut)	KWS Saat AG	R	2001
DE	39904508	 violett P 28730,S 28900,P 28765	31 (Tierfutter)	Effem GmbH	R	2004
DE	39919998	 grün / green RAL 1506040	11 17 19	Aquatherm GmbH	R	2004
DE	39919999	 ...grün / green RAL 1704040-1506040	11 17 19	Aquatherm GmbH	R	2003
DE	39921546	 blau, grau / blue, grey	35 36 37 41 42	Drees & Sommer AG	R	2000







DE	39927141	 Pantone,13-0859Tc-19-3955Tc	18 20 21 22 25 27	LARCA Sportartikel GmbH	R	2003
DE	39932963	 blau, bernstein / blue, amber	35 38 41	Kienbaum Consulting	R	1999
DE	39932964	 bernstein, blau, weiß / amber, blue, white	35 38 41	Kienbaum Consulting	R	1999
DE	39932966	 blau, weiß / blue, white	35 38 41	Kienbaum Consulting	R	1999







DE	39972469	  rot, grün / red, green		Melitta	R	2002
DE	30038516	   hellgrün (Pantone 375 C), dunkelgrün (RAL 6002), rot (RAL 3020), weiß (RAL 9010) light green (Pantone 375 C), dark green (RAL 6002), red (RAL 3020), white (RAL 9010)	3	Zielinski, Gabriele	R	2001
DE	30057885	    verkehrsrot, lichtgrau, basaltgrau, tiefschwarz / traffic red, light grey, basalt grey, dark black	39	Deutsche Bahn AG	R	2001







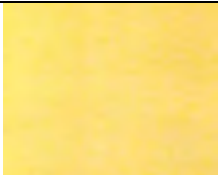

DE	30084703	 hellblau, grün / light blue, green	9 16 38	Urban & Fischer	R	2001
DE	30116169	 grün, gelb, rot / green, yellow, red	31	Becker, Jun.	R	2001
DE	30124494	 Zinkgelb, verkehrsrot, verkehrsblau / zinc yellow, traffic red, traffic blue	4 9 38	Germann Immobilien & Verwaltungs GmbH	R	2002



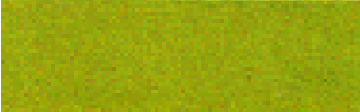

DE	30124495	 blutorange, pastelorange / blood orange, pastel orange	4 9 38	Germann Immobilien & Verwaltungs GmbH	R	2002
DE	30127389	 gelb HKS 5, violett HKS 34	12	Wohlfarth	R	2003
DE	30129024	 gelb, blau / yellow, blue	35 36 38	BVL Bürosysteme Vertriebs GmbH	R	2001
DE	30129947	 Grün / green Pantone 236	36	Dresdner Bank AG	R	2004
DE	30137245	 blau, grün, rot, grau / blue, green, red, grey	35 42	Rae Rayermann Zimmer	R	2001



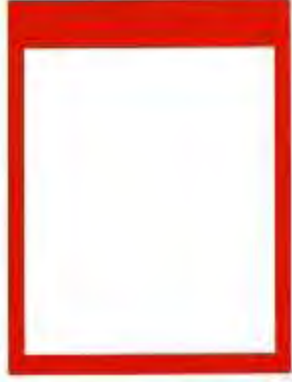

DE	30153125	 <p>verkehrsorange, minzgrün, signalblau / traffic orange, mint green, signal blue</p>	7	Vogel Industrie GmbH	R	2002
DE	30160439 24W(pat) 104/04	 <p>helles Orange HKS 6N 20-0 / light orange HKS 6N 20-0</p>	17 19	Owens Corning Inc	E A W	2006
DE	30166245	 <p>blau, violett, rot / blue violett, red</p>	12 25 35 37	Bayrische Motoren Werke AG	R	2002
DE	395 1 C049/02 [EuGH)	 <p><i>Die o.g. Wiedergabe zeigt nur die Wiedergabe der beiden Farben anhand einer älteren Markeneintragung der Antragstellerin.</i></p> <p>Bei der angemeldeten Marke handelt es sich um die Firmenfarben der Anmelderin, die in jeglichen denkbaren Formen benutzt werden, insbesondere für Verpackungen und Etiketten. Die genaue Bezeichnung der Farben ist wie folgt: RAL5015/HKS47 - blau, RAL1016/HKS3 – gelb</p>	1 2 3 4 5 6 7 8 9 17 19 20 24	Heidelberger Bauchemie GmbH	A	2004



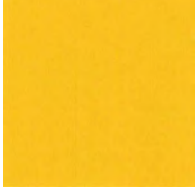

		The above representation shows the color combination as used in an elder trade mark registration of the applicant. The exact definition of the colors is RAL5015/HKS47 - blue, RAL1016/HKS3 - yellow				
DE	30225091	Farbe Grün (RAL 6018), in der die Gehäuse der beanspruchten Waren ausgeführt sind.	9	Jürgen Spelsberg GmbH & Co KG	R	2004
DE	30231621	 rot / red (RAL 3000)	7	KTR Kupplungs-technik GmbH	R	2003
DE	302402969	 red / rot RAL 2002	9	Dehn + Söhne	R	2008
DE	30245399	 Pinkrot (Pantone 227C)	5 30 43		E A W	2006
DE	30245400	 rosa / rose (Pantone 493 C)	5 30 43		E A W	2006
DE	30245402	 orange (Pantone 152C)	5 30 43			
DE	30245403	 Hellgelb / bright yellow (Pantone 609C)	5, 30, 43		E A W	2006

DE	30245404	 Türkis / turquoise (Pantone 3258C)	5 30 43		E A W	2006
DE	30251717 29W(pat) 68/03	 dunkelblau (RAL 5015) / hellblau (RAL 5012)	7	Winterhalter Gastronom GmbH	E A R	2006
DE	30253370	 Grün, grün, gelb / green green yellow	4	Deutsche BP	R	2004
DE	302253369	 grün/ green (P 348C), gelb / yellow (P 109C)	4	Deutsche BP	R	2004
DE	302344438	 gelb / yellow	9	YXLON international X-Ray	R	2008
DE	30259878	 Gelb / yellow HKS 3	39 40	YELLO Strom	R	2004
DE	30301934	 Pantone grün C	9 16 35	Fraunhofergesellschaft	R	2003



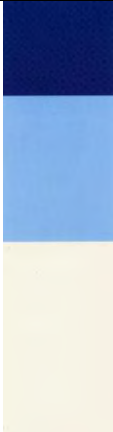
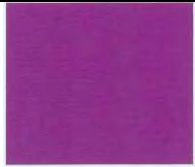



DE	30327887	 verkehrsrot / traffic red (RAL 3020)	7 9 11 12	Hydac International GmbH	E A W	2007
DE	30344272	 rot / red Pantone 485 C	10	Matsushita	R	2004
DE	30359376	 kupfer / copper (pantone orange Nr. 021C mit Metallic-Effekt)	30	FerreroOHG	R	2004
DE	30362221	 blau / blue pantone 392	1 17	Siga Cover	E	2006
DE	30362241	 grün / green pantone 376	17	Siga Cover	E	2006
DE	30362242	 ... Gelb pantone process yellow	17	Siga Cover	E	2006
DE	30362522	 blau / blue grün / green RAL 280 40 45 RAL 150 60 40	19	Aquatherm GmbH	R	2004
DE	304376302	 sonnengelb HKS-Ton 3	16	Verlag neue Wirtschaftsbriefe	R	2008





DE	30440591	 rot	16	Spiegel Verlag Rudolf Augstein	R	2005
DE	30458740	Green / Grün Pantone 372 C	3	Rosmarin kft	E	2006
DE	30460286		5 29 30 32	Haleko	R	2005
DE	304683396	 pantone 258	1	Henkel AG & Co	R	2009
DE	304692441	 rapsgeib RAL 1021	16 41	Gelbe Seiten	R	2008
DE	30469630	Pink		REHAU AG + Co	R	2007









DE	30470261	 Gelb	39	Deutsche Post AG	R	2007
DE	30509339	 Magenta: Pantone Rhodamine Red U RAL 4010	28 32 35 36 41 42	Deutsche Telekom AG	R	2005
DE	305187355		9 42	Gesellschaft für Netzwerk und Unix-Administration	E W	2006
DE	30522791.2	 Raps gelb RAL 1021	7 8 10	Ernst Vetter GmbH	E	2006
DE	30525583	 zinkgelb	7	Alfred Kärcher GmbH	R	2005
DE	30525602	 blue / blau	9	Micronas GmbH	R	2005



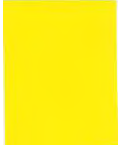
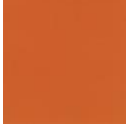





DE	30531701		16	Georg Thieme Verlag	R	2006
DE	30537272	 Verkehrspurpur RAL 4006	17	Vallourec & Mannesmann Tubes	R	2005
DE	30540857	 Sandgelb RAL 1002	17 19	Poloplast GmbH	R	2007
DE	30571072	 BLAU Pantone 280C	3	Beiersdorf AG	R	2007
DE	306094851		2 7 11 16 20 21 24 27 35	Poco Holding	E W	2007



DE	30621545	 Rot RAL 3020	7	Hilti AG	R	2007
DE	30631881	 rot	16	Verlag CH Beck oHG	R	2008
DE	30636084	 Lachsrosa	16 41	Financial Times Deutschland	R	2007
DE	306424975	"rot" (RAL 3000) und "gelb" (RAL 1021). Die beanspruchten Waren sind dabei farblich wie folgt aufgemacht: Chassis in "rot", Radkappen in "gelb", Fangkörbe in "rot" und  Bedienelemente/Verstellknöpfe in "gelb".	7	MTD Products Inc	R	2009
DE	30701347	 Enzianblau	35 39	Brenner Holding GmbH	R	2008
DE	30729375	 goldgelb (RAL 1004)	9	Peter Hirt GmbH	R	2008



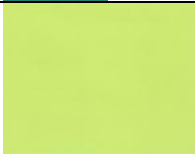

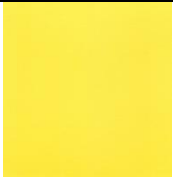

DE	30737813		Braun (RAL 0505050)/ Schwarz (RAL Classic 9011)	7	Kuka Roboter GmbH	E A W	2008
DE	30737814		Orange (RAL 0505050)/ Schwarz (RAL Classic 9011)	7	Kuka Roboter GmbH	E A W	2008
DE	30771435		orange, hellgrau	7	Andreas Stihl AG	R	2008
DE	307755681	Rot / red		7 8 11 21 28	Hellweg die Profibaumärkte	E W	2008
DE	302008 00227		green / grün (NCS-Wert 5020-G70Y)	16	Marcus Sommer SOMSO Modelle GnbH	R	2008
DE	302008 0161094		lichtgrau , verkehrsrot	39	Deutsche Bahn AG	R	2008
DE	302008 0302666		RAL 1021 - Rapsgelb	9 16 35 38 41 42	DETEMEDIEN	R	2008



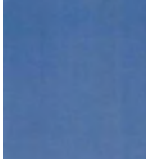

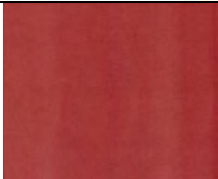

DE	302008 0376600	 Farbmarke ("NJW-Orange"). Der Farbton ist nach dem international anerkannten L *a*b*-System eindeutig wie folgt definiert: L: 57,30/a: 59,69/b: 47,25. Es handelt sich bei der Farbmarke nicht um einen im RAL-, Pantone- oder HKS-System verzeichneten Farbton, sondern um einen extra für die Anmelderin angemischten Farbton mit der internen Bezeichnung des Herstellers K+E 194 156. Die Marke wird seit vielen Jahren für die Neue Juristische Wochenschrift, Deutschlands mit Abstand größte und bekannteste juristische Fachzeitschrift und deren Werbung benutzt. Sie wird von keiner anderen juristischen Fachzeitschrift in Deutschland verwendet	16	Verlag C.H. Beck	R	2009
DE	302008 0463392	 light blue / lichtblau (HKS-K46)	12	Gesutra GmbH	R	2009
DE	302008 0511168	 konturlose Farbmarke in Form einer Farbkombination. Die einzelnen Farben der Farbkombination sind in Form geradliniger Streifen in vertikaler Richtung übereinander angeordnet, wobei die einander in vertikaler Richtung benachbarten Farben je-weils ohne Zwischenraum aneinander angrenzen. Von oben nach unten folgen die nach-stehenden, jeweils nach einem international anerkannten Farbklassifikationssystem spezifizierten Farben der Farbkombination in der nachstehenden Reihenfolge und mit den nachstehenden Anteilen an der Gesamthöhe der Farbkombination aufeinander: Farbe: Weiß, Spezifikation: NCS S 0505-R80B, Anteil: 34%; Farbe: Silber, Spezifikation: RAL 9006, Anteil: 1,5%; Farbe: Blau, Spezifikation: RAL DESIGN 250 20 20, Anteil: 32,5%; Farbe: Weiß, Spezifikation: NCS S 0505-R80B, Anteil: 32%	7	Trumpf GmbH & Co	R	2008
DE	302008 0539844	 blue / blau	1 4 37	BP Europa SE	E R	2012



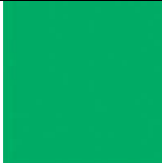

DE	302008 0582766		4 39	N.V. Nuon Energy	R	2009
		lilac / yellow lila, gelb				
DE	302008 0588772		11	HG Baunach GmbH	E W	2009
DE	302008 0613769		16 41	Verlag Neue Wirtschaftsbriefe	E R	2010
DE	302008 0669519		35	OBI AG	E W	2009
DE	302008 0634642		12 373	Eugen Trost gmbH	E	2013
DE	302008 0717238		9	J. Dittrich Elektronik GmbH	E	2013
DE	302008 0781688		35 37 41 44	Jan Bockholdt	E W	2010
DE	302009 0071675		11 17 19	Aquaterm GmbH	E W	2011
DE	302009 0122008		1 3 5	Reckitt Benkieser N.V.	E W	2011

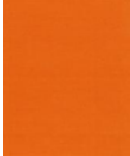



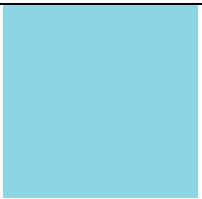

DE	302009 0214743		35	Schuh-Braun Veertriebs GmbH	E W	2010
DE	302009 0360804		7	Hans Ullrich Werner	E W	2010
DE	302009 03600790		7	Hans Ullrich Werner	E W	2010
DE	302010 0367385		35	OBI GmbH & CO	R	2012
DE	302010 0375930		12 254 37 39	Karl-Heinz John	E W	2011
DE	302010 0495472		7	Schmid & Wezel GmbH & Co.	R	2012
DE	302010 0680067		16 41 42	Deutsche Vereinigung für gewerblichen Rechtsschutz und Urheberrecht	E W	2011
DE	302010 0757191		25	Gisy Schuhe GmbH & Co KG	E W	2012
DE	302010 0760575	 Sonnengelb / sun yellow	38	NWB Verlag	R	2013





DE	302011 0073619		9	Pilz GmbH & Co	E W	2013
DE	302011 0216185	 verkehrsdurchgesetzt / secondary meaning grün / green (Pantone 367, HKS 55%, HKS 67)	16 41 42	Deutsche Vereinigung für gewerblichen Rechtsschutz und Urheberrecht	R	2011
DE	302011 0320098		9 16 18 28 38 41 42	Hermedia Verlag	E	2016
DE	302011 0346321		9	SMA SOLAR Technology	E W	2012
DE	302011 0399034	 Pink (Pantone 677 C, edition 2010).	10	Ceramtec GmbH	R	2013
DE	302011 0409560		29 30 35 43	Mundfein GmbH	E W	2013
DE	302011 0577048		39	Berliner Verkehrsbetriebe	E W	2014
DE	302011 0583080		1 16	Ruderer Klebtechnik GmbH	E W	2013

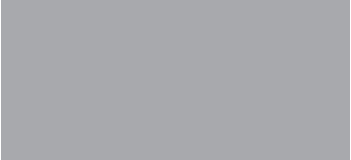

DE	302011 0635862		7	Amazonen Werke H. Dreyer GmbH & Co KG	E	2016
DE	302012 0206875		7	Lemken GmbH & Co KG	R	2015
DE	302012 0334938		35	Britta MEYER	E W	2013
DE	302012 0378676		7	ABB AG	E	2016
DE	302013 0239547		36	Deutscher Sparkas-sen- und Giroverband	E	2016
DE	302013 0301706		33	Weingut Robert Weil	E W	2013
DE	302014 0205580		14	Tiffany & Co	E	2016



DE	302014 0216779		12	European Trailer Systems GmbH,	E	2016
DE	302014 0422174		5 10	Minerva GmbH	E	2016
DE	302014 0426854		33	Rüdesheimer Weinkellerei GmbH	E W	2015
DE	302014 046019		9 10	Neomed Medizin Vertrieb+Logistik GmbH,	E	2016
DE	302014 0716429		5	Dr. Muche GmbH	E W	2015
DE	302014 0751089		9	Daqo Group Ltd	E W	2015
DE	302015 0101478		16 21 33	T Prinz	E W	2016



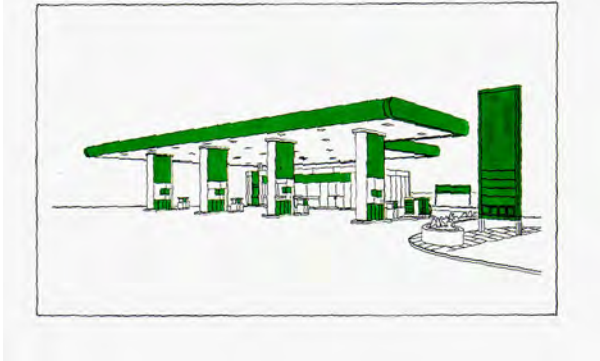

DE	302015 0367133			35 42	S Zech	E W	2015
DE	302015 0444324	 lily / lila (Pantone code 2587C)		5 10	Glaxo Group Ltd	R O	2015
DE	302015 1048708	 blue / blau (RAL 220 80 25)		6	M2 Entwicklungs- Produktions- Vertriebs GmbH	R	2016
DE	302015 0597708			45	Hogan Lovells	E W	2016
DE	302015 0638358	 Pantone 186C		7	Lely Patent N.V	R	2016

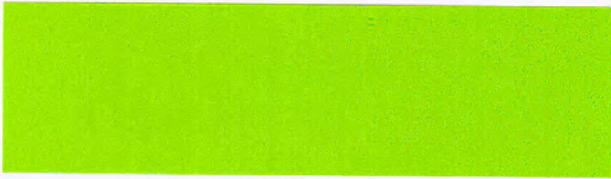

DE	302016 0262407		30	Chocoladefabriken Lindt & Sprüngli AG	E W	2017
DE	302016 0296441		35 37 42	BUG Rohrreinigung GmbH	E W	2017
DE	302016 0315527		4 7 37	Siegmund Hoffmann GmbH	E W	2017
DE	302017 085044		5	Merck KGaA	E W	2017
DE	302017 0100728		9 16 17 35 37 38 39 41 42	Giesecke + Devrient	E W	2018
DE	302017 01000736		9 16 17 35 37 38 39 41 42	Giesecke + Devrient	E W	2018
DE	302017 01000744		9 16 17 35 37 38 39 41 42	Giesecke + Devrient	E W	2018



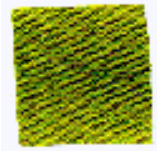

DE	302017 0106750		gold (Pantone Premium Metallics coated 10126 C)	30	Chokoladenfabriken Lindt & Sprüngli	R	2017
DE	302017 0158262		Pantone Premium Metallics coated 10126 C	30	Chokoladenfabriken Lindt & Sprüngli	R	2017
DE	302018 0133149		Gelb / yellow	9 16 41 42 45	Deutsche Institution der Schiedsgerichtsbarkeit e.V.	E W	2018
EE	48763		lilac / Lila Pantone 2627	30	Löfberg aktiebolag	R	2011
EE	54027		dark green dunkel grün (PMS: 343)	29	AS HKScan Estonia	R	2016

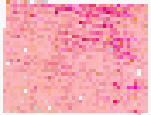



EM	0001991	 <p>(durchgesetzt)</p> <p>Besteht aus der Farbe Grün, wie auf der Außenfläche der Verkaufsräumlichkeiten angebracht. Die Eintragung dieser Marke berechtigt nicht zur exklusiven Benutzung der Farbe Grün, wie sie für Pumpen, Düsen und Schläuche für die Abgabe von bleifreiem Benzin verwendet wird. The mark consists of the colour green as applied to the exterior surface of the premises used for the sale of the goods and services. Registration of the subject mark shall give no right to the exclusive use of the colour green as applied to pumps, nozzles and hoses used for the delivery of unleaded petrol.</p>	4 37	BP p.l.c.	R	2001
EM	31336	 <p>Lila, einfarbig wie in der Wiedergabe. lilac, one color as in the representation</p>	30	Kraft Foods Schweiz Holding AG	R	1999
EM	46565	 <p>Schwarz (RAL 2005) / Zinkgelb (RAL 1018) Black: RAL 9005, zinc yellow: RAL 1018.</p>	1 3 5 6 7 9 11 12 21 22 23 37 42	Alfred Kärcher GmbH & Co	A E W	2002





EM	51607	 <p>Besteht aus der eigentlichen Farbe Hellgrün in der speziellen Tönung, wie sie das beigefügte Farbmuster wiedergibt. Der Markenschutz wird für diesen speziellen Farbton beansprucht und nicht für die besondere rechteckige Form des Farbmusters. Zur Stützung dieser Anmeldung hat der Antragsteller darüber hinaus eine Standard-Farbtabelle beigefügt. Der senkrechte Block in der Mitte dieser Tabelle zeigt den speziellen Grünton, dessen Schutz beantragt wird, die anderen Quadrate geben die verschiedenen Farbtoleranzen dieser speziellen Tönung wieder.</p> <p>The trademark consists of the colour light-green itself in the specific hue as is shown on the enclosed specimen of the colour. Trademark protection is claimed for this specific hue of the colour and not for the particular rectangular form of the colour specimen. Also enclosed is "Color Standard Chart" from the Applicant in support of this application. The vertical block in the middle of this chart shows the colour green in the specific hue claimed, the other squares show the various colour tolerances of this specific hue.</p>	3 5 30	WM Wrigley Jr. Company	A W	2001
EM	52035	 <p>Das Markenzeichen besteht in der speziellen Schattierung der Farbe Gelb, wie sie das beigefügte Farbmuster zeigt. Markenschutz wird beansprucht für die spezielle Färbung als Grundfarbe des Verpackungsmaterials für die eingetragenen Waren und nicht für die besondere rechteckige Form des Farbmusters. Darüber hinaus hat der Antragsteller als Beleg seiner Anmeldung eine Farbkarte beigefügt. Der vertikale Block in der Mitte der Karte zeigt die Farbe Gelb in der speziellen Schattierung gemäß dem Anspruch, die Quadrate</p>	3 5 30	WM Wrigley Jr. Company	A W	1999

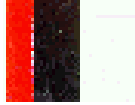

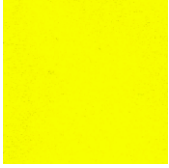



		<p>zeigen die verschiedenen Farbtoleranzen dieser speziellen Schattierung. The trademark consists of the colour yellow itself in the specific hue as is shown on the enclosed specimen of the colour. Trademark protection is claimed for this specific hue of the colour as the basic colour of the packaging material of the goods claimed, and not for the particular rectangular form of the colour specimen. Also enclosed is a "Color Standard Chart" from the Applicant in support of this application. The vertical block in the middle of this chart shows the colour yellow in the specific hue claimed, the squares show the various colour tolerances of this specific hue.</p>				
EM	55475	 <p>Farbe Türkis. The colour turquoise</p>	9 16 36	Barclay's Bank	W	1999
EM	63289	 <p>Grün: Munsell 9.47 GY3.57/7.45; Gelb: Munsell 5.06 Y7.63/10.66.</p>	7 12	Deere & Company	R N	2001 2004
EM	127407	 <p>Blau. Blue</p>	4 37	ARAL AG	A W	2000
EM	142612		2 4	WD-40 MANUFACTURING COMPANY	W	2000
EM	152314	 <p>grüngold auf der Warenoberfläche /green gold on the surface</p>	7	QUALITEX Inc	W	1998



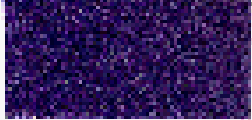

EM	156380	 Blau / blue	1	Compo GmbH & Co KG	W	
EM	171926	 Die Marke ist die Farbe Rosa. Die Marke beschränkt sich nicht auf die vier-eckige Form des vorgelegten Ausdrucks, sondern besitzt eine unbestimmte Form, da sie auf das Isoliermaterial des Produkts und seine Verpackung aufgebracht wird.	17	Owens Corning Inc	E W	2001
EM	212753	 Magenta Grau	38 42	Deutsche Telekom AG	R	2000
EM	212787	 Magenta Magenta	38 42	Deutsche Telekom	R	2000 2003
EM	240259	Rot: HKS 14; Pantone 1795; RAL 3020; Euroskala: 100% Magenta [rot], 80% Yellow [gelb] - Schwarz: HKS 88; Pantone Process Black; RAL 9005; Euroskala: 100 % Tiefe [schwarz], 100% Cyan [blau] - Lichtgrau: 25% HKS 88; Pantone 428; RAL 7035; Euroskala: 20% Tiefe [schwarz], 5% Cyan [blau].	4 37 39 42	RWE DEA	W	1999
EM	240952	 Orange	7 8 9 17	BV Holmatro Industrial Equipment	A W	2001



EM	275487	 Pantone 3125 C (türkis) / Pantone 3125 C (turquoise)	17	Busak & Shamban GmbH & Co	A W	2002
EM	282079	 ...Schwarz und gelb (pantone 108)	9	FSI Fonts und Software	W	1
EM	283530	 RAL 2001-HR (orange)	7	C & E Fein GmbH & Co KG	A W	2002
EM	319962	 Uhrgehäuse dunkelgrau UN 9003 Bedienungstaste grün UN 6007 Dunkelgrau = UN 9003, grün = UN 6007 (Farbspezifikation gemäß dem Standard "Universal Masterbatch Color-Service / Hainburg" für Kunststoff-Einfärbung). Farbkombinations-Marke; Uhrgehäuse: dunkelgrau; wenigstens eine Bedienungstaste im Uhrgehäuse: grün. / dark grey = UN 9003, green = UN 6007 (color specification according to Standard "Universal Masterbatch Color-Service / Hainburg for plastic coloring).	14	Junghans Uhren GmbH	A W	2001



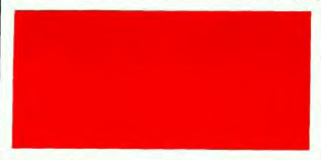

EM	338194	 Orange (Pantone 164c) und Grau (pantone 428) / orange (pantone 146c) and grey (pantone 428)	7	Andrea Stihl AG	A	2001
EM	343368	 Gelb (Die Munsel-Nummer der Farbe Gelb lautet 9 YR 7.36/14.6.)	9 16	FLUKE Corp.	W	2000
EM	355909	 feuerrot (RAL 3000) reinweiß (RAL 9010) tiefschwarz (RAL 9005).	7 9	Windmüller & Hölscher GmbH	R	2001
EM	374173	 Türkis / Turquoise.	1 16 17	Perfecta Chemie BV	W	1999
EM	378224	 Pantone 1555 C (rosa) / The trademark consists of the pink shade PANTONE 1555 C, as repre-sented in the brand model, corresponding to the colour of the product.	3	Lancome Parfums et Beaute & cie	A W	2002
EM	396176	 gelb / yellow	2 16 17	Northern Technologies Inc.	R	2001





EM	459149 T316/00 [EuG]	 Die Marke ist eine Zusammenstellung von zwei Farben, die wiedergegeben ist durch ein grünes Rechteck mit dem Farbton Pantone 369c und ein darunter liegendes graues Rechteck mit dem Farbton Pantone 428u. / The trademark is a two color combination represented by a green rectangle having the color Pantone 369c and a rectangle below said rectactle in grey having the color Pantone 428u	7	Viking-Umwelt-technik GmbH	A W	2002
EM	469213	 hellgrün / light green	7 12	Claas KG aA GmbH	A W	2001
EM	474106	 Hellblau (pantone 290U)	10	Arrow International	W	1999
EM	475210	 blau pantone 289 / gelb pantone 123 (verkehrsds.) pantone 289 / yellow pantone 123 (aquired Distinctiveness)	16 39 42	S.N.C.F.	A R	2004
EM	524850	 RAL 2004 reinorange	7 8 9	Cooper POWER tools GmbH	W	2000



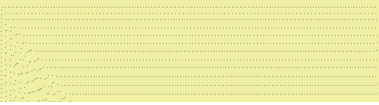

EM	546713	 dunkelviolet	7 8 12	Sparky trading	E W	2002
EM	565523	 Blau (HKS 43 K) / Blue (HKS 43 K).	16 29 42	Staatl. Molkerei Wihenstephan	W	1999
EM	590307	 Dunkelviolet	3	3 M Company	W	2000
EM	611517	 GRÜN HKS Nr. 55 K 55% / Green HKS Nr. 57K, 55%.	17	BASF AG	A W	2002
EM	6111558	 GRÜN HKS Nr. 64 K 30% / Green HKS Nr. 64 K, 30%	17	BASF AG	W	2000
EM	611566	 GRÜN HKS Nr. 55 K 30% / Green HKS Nr. 55K, 30%.	17	BASF AG	A W	2002

EM	611590	 GRÜN HKS Nr. 54 K 30% / Green HKS Nr. 54K, 30%.	17	BASF AG	W	2000
EM	611616	 GRÜN HKS Nr. 57 K 30% / Green HKS Nr. 57K, 30%.	17	BASF AG	A W	2000
EM	614420	 Weiss / rot (pantone 032c) / Colour: white, red. (Other term for red colour: HKS 13 Pantone red 032c (100% yellow / 100% magenta))	9 16 38	Herlitz PBS AG	A R	2001
EM	619676	 Besteht aus der Farbe Rot (Pantone-Vergleichssystem 186), von der weiter oben ein Muster gezeigt wird; sie bedeckt die Waren vollständig oder zu einem wesentlichen Teil oder ihre sichtbare Oberfläche. / The mark consists of the colour red (Pantone Matching System 186), a sample of which is shown, covering the whole of, or a substantial part of, the visible surface of the goods.	6	The Crosby Group	A W	2003
EM	655019	 Kanariengelb Die Standardwerte (Koordinaten im Farbbereich) für die Marke sind: L = 93.77;a = -5.28;und b = 38.43.Die Farbnummern im Pantone Matching System®, die diesen spezifischen Koordinaten im Farbbereich am	16	3 M Company	R	2004



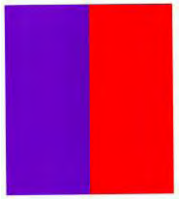

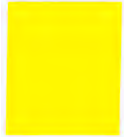

		nächsten kommen, sind Pantone® Nr. 106 60 %, Pantone® Nr. 601 100 %, Pantone® Nr. 101 50 % und Pantone® Nr. 100 60 %				
EM	683813	 violett	29 30	CADBURY	W	2000
EM	708776	 grün / green	4	Alexander Duckham	E W	2001
EM	711275	 RAL 1032 (gelb) / RAL 1032 (yellow)	16 35 36 38 39 42	Deutsche Post AG	A W	2001
EM	742304	 Gelb / Yellow	8 9 12 37 40 41	LuK Lammellen und Kupplungsbau GmbH	E A W	2002
EM	742379	 Gelb , Schwarz / yellow, black	8 9 12 37 40 41	LuK Lammellen und Kupplungsbau	E	2002
EM	747501	 Pantone 348 (grün) / Pantone 348 (green)	39	National Car rental Systems, Inc.	A E	2003



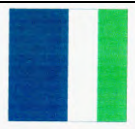

EM	747949	 <p>Der Schutz wird beantragt für die Farbe Orange, deren wissenschaft-liche Definition folgendermaßen lautet: Dreifarbenkoordinaten / kolorimetrische Eigenschaften: x 0,520, y 0,428 - Faktor der diffusen Reflexion 42,3% - Maßgebende Wellenlänge 586,5 nm - Spektraler Farbanteil 0,860 - Farbdichte der Strahlung: 0,894. Protection is claimed for the colour orange for which the scientific definition is as follows: trichromatic co-ordinates / colour characteristics: x 0.520, y 0.428 - diffuse reflectance 42.3% - dominant wavelength 586.5 nm - excitation purity 0.860 - colorimetric purity: 0,894.</p>	32 33	Veuve Clicquot Ponsardin	A	2004
EM	772244	 <p>Hellrot/dunkelrot; dunkelrot entspricht RAL Nr. 3002 oder Pantone 1805C; hellrot entspricht RAL Nr. 2002 oder 2004 oder Pantone "Warm Red C")</p>	30	Paul Reber	W	2000
EM	773630 T137/00 [EuG] C447/02 (EuGH)	 <p>Orange HKS7 / Orange (HKS7).</p>	7 11 31 42	KWS Kleinwanslebener Saatzucht AG	A	2005
EM	867408	 <p>(durchgesetzt /acquired distinctiveness) Aubergine (RAL 4007)</p>	7	MCC Nederland B.V.	R	2001





EM	890350	 dunkelrot entspricht RAL Nr. 3002 oder Pantone 1805C	30	Paul Reber	W	200
EM	892836	 Chamois HKS 3-30%	30	Paul Reber	W	
EM	904169	  Pantone 375c (Hellgrün) / RAL 6002 (Laubgrün) / Pantone 375 (light green); RAL 6002 (leave green)	3	Zielinki, Gabriele	A, W	2002
EM	905172	 Türkis Orange / turquoise orange	9 38 42	BELGACOM	W	2002
EM	944397	 Die kolorimetrische Bestimmung des Farbtons nach der L*a*b*-Darstellung (Internationale Beleuchtungskommission - 1976) ist die folgende: L*=52.53; a*=60.39; b*=+26.23 (wobei L* den Helligkeitsfaktor angibt und a* und b* die Farbkoordinaten sind)..	1 29 30	Etabl. Ancelm Fabrique	W	2003

EM	962076	 (durchgesetzt /acquired distinctiveness) braun /brown	39	United Parcel Service of Amerika	R	2001
EM	968131	 Lila und rot / lilac and warm red	9 38 42	Belgacom	W	2002
EM	988865	 apricot	6 11 20 21	HEWI	W	2001
EM	1000082	 Gelb / yellow	4	LuK ...	W	2001
EM	10000132	 Gelb / schwarz	4	LuK	W	2001
EM	1004217	 Pantone 343c	20 24 25 27	Laura Ashley	W	2000

EM	1014166	 Besteht aus der Farbe Blau, wie oben gezeigt, auf der Außenfläche der die Anmeldung betreffenden Waren. / The mark comprises the colour blue as shown above, applied to the exterior surface of the goods covered by the application.	16 17 41	3M Company	W	1999
EM	1029554	 Blau / blue PMS 300 U (durchgesetzt /aquired distinctiveness)	20 39	Brambles Australia	R	2003
EM	1074095	 Pantone 321 cv	16 28	melloc	W	2001
EM	1143569	 Hellblau (pantone 657u) / anthrazit (pantone 433u)	9 16 35 356 38 42	Landesbank Baden Württemberg	W	2001
EM	1144057	 Hellblau (pantone 657u)	9 16 35 356 38 42	Landesbank Baden Württemberg	W	2001
EM	1174143	 Blau (Pantone 19-3955TC). Gelb (Pantone 13-0859TC); Yellow (Pantone 13-0859TC); blue (Pantone 19-3955TC).	9 12 18 20 21 24 25 27 28	Larca Sportartikel	E A W	2003





EM	1178904	 enzianblau RAL 5010; pastellorange RAL 2003	7 9 42	Rexroth Indramat	W	2001
EM	1178938	 enzianblau ral 5010; signalweiø ral 9003; pastellorange ral 2003	7 9 42	Rexroth Indramat	R	2000
EM	1179035	 enzianblau RAL 5010; signalweiø ral 9003; verkehrsgrün RAL 6024	7 9 42	Rexroth Indramat	R	2000
EM	1179076	 enzianblau ral 5010; signalweiø ral 9003; pantone 108	7 9 42	Rexroth Indramat	R	2000
EM	1189471	 Schwarz / black orange (RAL 2008)	12 36 39	SIXT AG	E W	2001
EM	1222330	 Gelb / yellow schwarz / black	7	The Black & Decker	E O	2003
EM	1222413	 Gelb / yellow schwarz / black	7	The Black & Decker	E O	2003







EM	1222561	 Gelb / yellow schwarz / black	7	The Black & Decker	E O	2003
EM	1233485	 Rot / red	7 8	Harvard International	E W	2000
EM	1279637	 dunkelblau / dark blue	11 16 20 21	SOFRIGAM	E W	2001
EM	1316611	 Besteht aus der Kombination der Farben Gelb (Pantone 123) und Grau (Pantone 431), die auf Waren aus der Liste der Waren und Dienstleistungen dieser Anmeldung angebracht sind. The mark consists of the combination of the colours yellow (as defined by Pantone No 123) and grey (as defined by Pantone No 431) applied to any of the goods included in the list of goods and services covered by this application.	7 17 21	Hozelock Ltd	R	2003
EM	1318658	 Anthrazit 100 % HKS 93; Chamois 30 % HKS 1 und 70 % weiß Die Farbe chamois bildet stets den Hintergrund für einen in anthrazit gehaltenen Aufdruck, welcher Symbole oder auch Schriftzeichen in Form von Buchstaben enthalten kann	16 20 25	März München AG	E W	2001

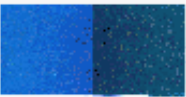
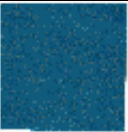

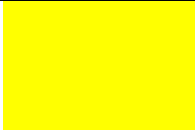
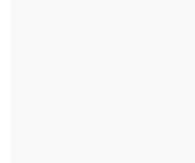





EM	1318898	 Hellblau / light blue	6 7 11 17	Tecnosystemi	E W	2001
EM	1328756	 Gelbverlauf von 100% Skalengelb bis 0% entsprechend der Europalette oder Gelbverlauf von 100% Process Yellow bis 0% Process Yellow entsprechend Farbsystem Pantone oder Gelbverlauf von 100% HKS 3 bis 0% HKS 3 entsprechend Farbsystem HKS	1 5 20 21	W Neudorff GmbH KG	E W	2003
EM	1334192	 Rapsgelb (RAL 1021), Himmelblau (RAL 5015)..	9	SICK AG	E W	2000
EM	1346931	 Türkis / turquoise	29	H.J. Heinz Company	E W	2001
EM	1353358	 Magenta: RAL 4010 bzw. Pantone Phodamine Red U	9 16 36 37 38 41 42	Deutsche Telekom	E W	2003





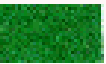

EM	1355015	 Magenta: RAL 4010 bzw. Pantone Phodamine Red U; Grau: RAL 745 bzw. Cool Grey 7 U	9 16 36 37 38 41 42	Deutsche Telekom	E W	2003
EM	1419555	 Gelb / yellow: HKS 4; blau / blue: Pantone 280; rot / red: HKS 14	9 14 16 18 25 28 35 36 38 39 42	Deutsche Post AG	E A W	2004
EM	1422005	 Gelb / yellow: HKS 4; blau / blue: Pantone 280	9 14 16 18 25 28 35 36 38 39 42	Deutsche Post AG	E A W	2004
EM	1422203	 Blau / blue	8	Philips Screw Company	E W	2002
EM	1422963	 Gelb / yellow : HKS 4, rot / red: HKS 14	9 14 16 18 25 28 35 36 38 39 42	Deutsche Post AG		2004
EM	1423698		9 14 16 18 25 28 35 36 38 39 42	Deutsche Post	E A W	2004
EM	1426493	 gelb / yellow HKS 4, Schwarz / black	9 14 16 18 25 28 35 36 38 39 42	Deutsche Post	E A W	2004



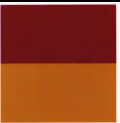



EM	1485093	 Fluoreszierendes Gelb	12 28 35 41	Jordan Grand Prix	E W	2004
EM	1520451	 orange	9 16 35 38 41 42	Big Words	E W	2003
EM	1536820	 Rot / red (pantone warm red c); gelb / yellow (pantone 1235 c)	1 2 17 19 27	SIKA AG	E W	2004
EM	1556711	 orange	6 8 16 20 42	Julius Blum	E W	2002
EM	1580588	 Reflex blau / blue	36 38 42	Banco Bilbao	E W	2002
EM	1599935	 Blau / blue	35 39	GALOL	E W	2001
EM	1606565	 Orange	39	TNT Holdings	E W	2002
EM	1631340	 PANTONE 109 C gelb / yellow, PANTONE 1795 C rot / red	32	Pago international GmbH	E W	2001
EM	1728419	 Kieselgrau RAL 7032; Grafitschwarz RAL 9011	6 7 9	Selcom Spa	E W	2001
EM	1771005		34	FORINEX	E W	2002

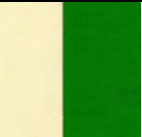



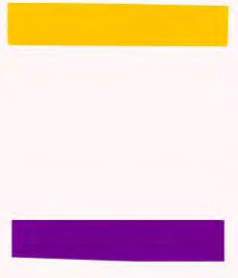

		Besteht aus der Farbe, die mit der Pantone-Farbe warmes Rot C dargestellt wird, die als vorherrschende Farbe die sichtbare Oberfläche von Warenverpackungen bedeckt. / The mark is the colour represented by Pantone Colour Warm Red C being the predominant colour applied to the visible surface of the packaging of the goods.				
EM	1771039	 Besteht aus der Farbe Pantone Grün 340C als vorherrschende Farbe der sichtbaren Oberfläche der Verpackung der Waren. / The Mark is the colour represented by Pantone Colour Green 340C it being the predominant colour applied to the visible surface of the packaging of the goods.	34	FORINEX	E W	2000
EM	1772961	 Orange Pantone 165 C	30	Carl Jürgen Brand	E W	2001
EM	1794072	 Rot / red pantone 206 C	7 9	Elletrotec s.r.l.	E W	2002
EM	1794098	 blau / blue (Pantone Nr. 308 C) rot / red (Pantone 1785C)	7 9	Elletrotec s.r.l.	E W	2002
EM	1794114	 blau / blue (Pantone 300U und Pantone 308C)	7 9	Elletrotec s.r.l.	E W	2002
EM	1794122	 blau / blue Pantone 308C	7 9	Elletrotec s.r.l.	E W	2002







EM	1796291	 Gelb / yellow pantone 106C	9	CABOT	E W	2001
EM	1808377	 Weiß / white	9	Horizont Gerätewerk	E W	2001
EM	1808393	 Grün / green	9	Horizont Gerätewerk	E W	2005
EM	1842608	 blau / blue pantone 2915C	34	John Players & Sons	E W	2002
EM	1842673	 Blau/ blue Pantone 2995C	34	John Players & Sons	E W	2002
EM	1848894	 Besteht aus der hinterlegten präzisen Wiedergabe des Farbtons, der wie folgt definiert ist: 11 pts WARM RED, 4 pts BLACK, 5 pts RUBINE RED The trademark consists of the exact shade of colour represented in the application and defined as follows: 11 pts WARM RED, 4pts BLACK, 5 pts RUBINE RED)	33	Champagne Vranken S.A.	E A W	2004
EM	1863232	 Violett / violet	5	3M ESPE AG	E W	2002
EM	1958032	 Die Marke besteht aus der Kombination der Farben Rot (Pantone 485 C)	11 16 21 30	Melitta Haushaltsprodukte	E W	2002





		und Grün (Pantone 3425 c)				
EM	2015857	 Grün: HKS 58 aufgeteilt in: C 90%, M 40%, Y 80%, K 65%; Gelb: HKS 4 aufgeteilt in: M 25 %, Y 100 %	31 40 41 42	Hüttner	E W	2002
EM	2037356	 Orange HKS 7	31	KWS Saat	E W	2006
EM	2057156	 gelb	7 12	J.C. Bamford Excavators	E A W	2006
EM	20849978	 orange	9 38	Orange Personal Communications	E R	2004
EM	2087005	 Rot RAL 3003 (durchgesetzt / aquired distinctiveness)	8 (Messer, Knives)	VICTORINOX	R	2004
EM	2089605	 Grün / green Pantone 355c	30	H.J. Heinz Company	E W	2002
EM	2111797	 blau / blue	7	Galol S.A.	E A W	2003
EM	2123370	 violett / violet	16 17 20	Gebr. Van Leeuwen	E W	200
EM	2131720	 grün / green pantone 355c	30	H.J. Heinz Company	E W	2002





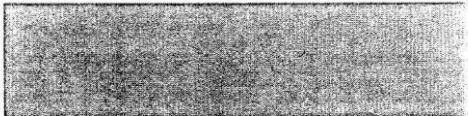

EM	2169563	 Violett / violet Pantone 272c	37 38 42	Spie Trindel	E W	2002
EM	2176519	 Bordeauxmetallic, gelbmetallic meliert	29 32 33	Cielo Spa	E W	2002
EM	2177566	 Blau / blue: Ral 5015, Rot / red: Ral 2002; Verteilung der Farben und Verhältnis der Farben zueinander 50:50	6 11 19 20	Gugelfuss	E A R	2005
EM	2228344	 Gelb grün blau / yellow green blue	35 37 39 40 42	RWE Umwelt AG	R	2002
EM	2255602	 blau weiß grün / blue white green	9 16 36	Standard Chartered Plc	E W	2004
EM	2297604	 Gelb / yellow Schwarz / black	7	The Black & Decker Corporation	E 0	2007
EM	2298719	 Gelb / yellow Schwarz / black	7	The Black & Decker Corporation	E 0	2007
EM	2342665	 grün / green RAL 6029; Chamois RAL 1015	35 36 42	Gastro Consult	E R	2005





EM	2389724	 Pantone (RAL 2002)	7 9 11	Pompes Salmson	E W	2003
EM	2430916	 grün / green pantone 343c	3 24 25 27 35 42	Laura Ashley Manufacturing	E W	2003
EM	2433001	 Gelb, Lila..	12	Klaus Wohlfarth	R	2004
EM	2467876	 Blau, violett, rot / blue , violet, red	12 25 35 37	BMW AG	E R	2006
EM	2476224	 hellblau / light blue (pantone 304) orange (pantone 152)	30 42	San francisco coffee company	E R	2005
EM	2494417	 orange (RAL 2000)	7 8 9 42	MSK Verpackung	E W	2006
EM	2523538	 La couleur la plus foncée est composée de 100% de ciel; magenta	29 30	Europeene de condiments	E W	2006

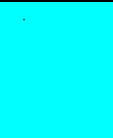

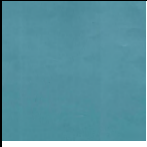

		79%, jaune 0% et noir 80%; la partie la plus claire et composée de 100% de ciel, magenta 79%, jaune 0% et noir 10%				
EM	2532471	 Orange (PMS 159C); blau / blue (PMS 303C)	8	Kapman AB	E A	2005
EM	2534774	 Der beantragte Schutz umfaßt die Farben Blau (RAL 5002) und Silber (Ral 9006) an sich	32	Red Bull GmbH	E R	2005
EM	2550457	 kanariengelb /n canary yellow	16	3M Company	E R	2005
EM	2571354	 Céladon (Pantone n° 7473U)	12 20	Glaverbel S.A.	E W	2004
EM	25807434		12 37	FILCO GmbH	E W	2004
EM	2600989	 HKS 5 Gelb / yellow , Schwarz Euro-Skala / black Euro scale	19 35 37	Xella Porenbeton	E W	2006
EM	2618668	 Orange blau / blue	7	Inter products B.V.	E W	2006

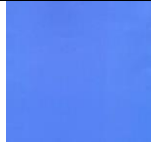





EM	2674307	 grün / green (pantone 363)	6 7 19	SPX Corp.	E W	2006
EM	2695732	 Türkis / Turquoise (Pantone No. 3268)	1 3 4 6 9 11 12 14 16 17 18 19 21 25 28 34 35 36	Petroliam National Behad	E W	2004
EM	2708634	 Rot / red (70 %); gelb / yellow (30 %) (die Farbe Gelb ist Pantone Nr. 108, die Farbe Rot wurde auf Grundlage einer Reflektionsmethode bei Zimmertemperatur und auf einem weißen Hintergrund mit folgendem Ergebnis gemessen: L: 5,00 A: 24,60 B: 7,66)	33	Flügel Enterprises	E W	2006
EM	2709731	 blau / blue (pantone 532 C)	16 41 42 43 44	The Ritz Hotel	E W	2003
EM	2709756	 gold pantone 872	16 41 42 43 44	The Ritz Hotel	E W	2003
EM	2710200	 Grün / green (pantone 371 C)	27	Milliken Industrial Ltd	E W	2006

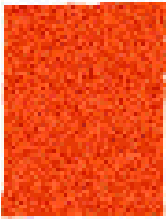

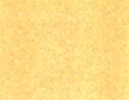

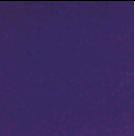
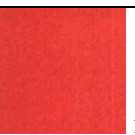
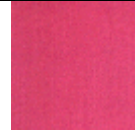

EM	2712412	 grau / grey pantone cool grey 7	1 3 4 6 9 11 12 14 16 17 18 19 21 25 28 34 35 36	Petroliam National Behad	E W	2004
EM	2712610	 - grau / grey pantone cool grey 4	1 3 4 6 9 11 12 14 16 17 18 19 21 25 28 34 35 36	Petroliam National Behad	E W	2005
EM	2712891	 - grau / grey pantone cool grey 10	1 3 4 6 9 11 12 14 16 17 18 19 21 25 28 34 35 36	Petroliam National Behad	E W	2006
EM	2716843	 Gelb / yellow , schwarz / black	7 9 20	The Black & Decker Corp.	E	2007
EM	2741023	 Blau / blue (RAL 5015) grau / grey (RAL 7031)	6 8 20	Unior Kovaska	E A W	2005









EM	2769404	 Die Farbe Blau mit platinfarbenen Flecken. The colour blue with platinum coloured flecks.	20	DataCard Corp.	R	2004
EM	2783686	 Blau / blue (pantone 293) grün / green (pantone 354)	36	Lloyds TSB Bank Plc	E W	2006
EM	2785384	 gelb / yellow schwarz / black	7 12 37	J. C. Bamford Excavators Ltd	E A W	2006
EM	2822476	 Gelb / yellow (Pantone 130), Blau / blue (Pantone 293)	36	Banca Intesa S.p.a.	E W	2004
EM	2825099	 0 % Grün / green: RAL HKS 57, 60 % Gelb / yellow: RAL HKS 2	7 11 35 37	Mann & Hummel GmbH	E R	2005
EM	2826428	 blau / blue	14 21	WEDGWOOD Ltd	E W	2006
EM	2829216	 Hellblau / light blue (pantone 3115c) bordeauxrot (pantone 215c)	39 40	Essent N.V.	E R	2005







EM	2851657	 graugrün / gery green (pantone 5483 C)	5 30 44	Kaniedenta GmbH & Co KG	E W	2006
EM	2852655	 Markenschutz wird beansprucht für eine Kombination von drei Farben, nämlich von blau, grün und violett, und zwar jede Farbe jeweils in einer helleren und einer dunkleren Schattierung (Farbmuster siehe Anlage); die drei helleren und die drei dunkleren Farben sind jeweils in horizontalen oder vertikalen Farbstreifen beliebiger Breite und Höhe angeordnet, wobei die dunkleren Farbfelder bei horizontaler Anordnung über und/oder unter den helleren Farbfeldern und bei vertikaler Anordnung rechts und/oder links neben den helleren Farbfeldern angeordnet sein können	16 35 41	IDG Entertainment Verlag	R	2004
EM	2854958	 Mittelblau / middleblue (pantone 2718 C)	5 30 44	Kaniedenta GmbH & Co KG	E W	2006
EM	2878114	 Himbeer / raspberry	3 8 9 11 13 14 16 18 20 21 25 28 33 34 35	Garrard Holding Holding	E W	2006













EM	2878171	 purpur /purple	3 8 9 11 13 14 16 18 20 21 24 25 27 28 33 34 35	ASprey	E W	2005
EM	2897031	 hellgrün / light green (pantone 368)	1	Accessories Marketing Inc.	E W	2006
EM	2898971	 Ziegelrot /brickred	20 27 28	Janssen Fritsen Holding	E W	2004
EM	2934271	 rot /red pantone 193	9	Sierra Wireless	E W	2004
EM	2936375	 grün / green RAL 6019	9	Günther Spelberg	E W	2006
EM	2965549	 Orange La marque est constituée par la nuance de couleur des	3 8 9 14 16 18 21 24 25	HERMES international	E W	2006







		conditionnements des produits. Elle se caractérise comme suit: L : 58.32 a : 41.91 b : 48.06 avec un delta E de 2 (mesure effectuée sous une illuminance de D 65/10°)..				
EM	3000700	 Cadmiumgelb RAL 1021	9 10	XYLON GmbH	E W	2006
EM	3011855	 Pantone 212C	1 3	Renkitt & Colman	E W	2006
EM	3011863	 violett Pantone 266C	1 3	Renkitt & Colman	E	2005
EM	3011871	 rot pantone 184C	1 3	Renkitt & Colman	E W	2006
EM	3012846	 rosa Pantone 232C	1 3	Renkitt & Colman	E W	2006
EM	3077625	 Grün / green RAL 5018	7 9 11 12 16 35 36 37 38 41 42	Siemens AG	E W	2006
EM	3086923	 orange	9 38	Orange Personal	E W	2005
EM	31103157	 Blau / blue pantone 301	35 42	Thomas & Betts international	E W	2006









EM	3119922	 Verkehrsrot RAL 3020	7 9 11	Hydac technology	E A	2007
EM	3145224	 Pantone 4-116	30	Fauchon	E W	2006
EM	3151008	 gelb schwarz / yellow black	9 16 35 36 42	ARAG Allgemeine Rechtsschutz-Versicherungs- AG	E R	2005
EM	3160074	 NCS S 1070-Y10R (yellow).	20 35	Inter IKEA	E W	2005
EM	3160199	 NCS S 4550-R80B (blue).	20 35	Inter IKEA	E W	2004
EM	3160363	 NCS S 4550-R80B (blue) NCS S 1070-Y10R (yellow)..	20 35	Inter IKEA	E A	2007
EM	3179281	 Pantone 131c	1 9 14 15 16 28 35 36 38	FNAC	E W	2006
EM	3187242	 Orange pantone 21	35 37 39	B & Q PLC	E A	2007









EM	3220134	 Purpur / purple Pantone 2623c	20 43	Whitebread	E W	2006
EM	3241205	 Himmelblau RAL 5015	17	Fietz GmbH	E W	2006
EM	3243623	 Purpur / purple pantone 2655	9 10	Safeskin	E W	2006
EM	3279361	 Signalblau RAL 5005	9	Krohne Messtechnik	E W	2006
EM	3309721	 Schwarz (Pantone 426 C) Silbergrau (Pantone 877 C metallics).	9	VB Autobatterie	E W	2006
EM	3314069	 Atlantik: Pantone 546C, Verkehrsschwarz: Pantone Black 2C 2X, Feuerrot: Pantone 485 C 2X..	7 9	Hans Einhell AG	E W	2006
EM	3314184	 RAL 1002 sandgelb / sand yellow	6 11 17 19	Poloplast	E W	2006
EM	3317948	 Blau / blue pantone 289 C, orange pantone 165C.	24 25 35	OVIESSE S.r.l.	E R	2005
EM	3370921	 blau / blue pantone 3005	7	Printing research	E W	2006

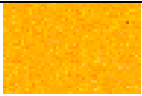

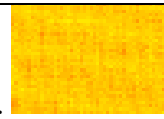

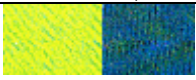

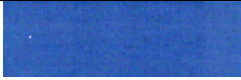

EM	3396801	 Curry(ocker)gelb RAL6003-HR/ olivgrün RAL 1027-HR	7 8 9	PROXXON	E	2007
EM	3425311	 Rot RALI 3020	7	Hilti AG	E A	2007
EM	3436961	 blau / blue Pantone 300C	35 38 40 41 42 44	TÜV Rheinland Holding	E W	2006
EM	3441854	 gelb / yellow pantone 116C	39	Hertz	E W	2006
EM	3485711	 grün / green pantone 350c	29 30 32	Tate & lyle	E W	2006
EM	3525938	 gelb / yellow pantone 1235c	1 9 16 35 37 39	Eastman Kodak	E	2007
EM	3527579	 The mark consist of the colours blue (as exemplified by pantone number 662C) and yellow (as exemplified by pantone number 123C) being the predominant colours applied to the exterior surfaces of parts of vehicles service station	1 3 4 35 36	ConoccoPhilips Co	E R	2007



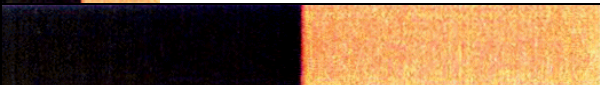

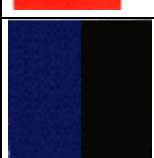

EM	3549034	 .pantone 5425	3 14 16 20 21	Llandro commercial	E W	2004
EM	3553187	 orange pantone 021.	38 39 43	Easy group IP	E W	2006
EM	3553633	 Pantone 9721 c/u / RAL 9001	9 16 35 38 41	Daimler Chrysler AG	E W	2006
EM	3553641	 Pantone 8004 C / RAL 1035	9 16 41	Daimler Chrysler AG	E W	2006
EM	3553658	 Pantone 173c/U /RAL 2001	16 35 41	Daimler Chrysler AG	E W	2006
EM	3553773	 Pantone process blue	1 2 3	Akzo Nobel	E W	2006
EM	3572021	 Gelb / yellow pantone 809	6	Gunnebo industrier AB	E	2007
EM	3578000	 silber / silver Pantone 877	16	Henkel KG aA	E A W	2006
EM	3588779	   Blau / blue CMYK: C100/M75 , Weiß / white CMYK: CO/MO/YO/KO, Chrom / chrome CMYK: K30..	7 12 16 28 36 37 41 42	VW AG	E	2005
EM	3588787	  Blau / blue CMYK: C100/M75, Weiß /white CMYK:	7 12 16 28 36 37 41 42	VW AG	E	2005







		CO/MO/YO/KO..				
EM	3588811	 Blau / blue CMYK: C100/M75	7 12 16 28 36 37 41 42	VW AG	E W	2005
EM	3615507	 Ral 8004 Kupferbraun / copper brown	11 17 19	Poloplast	E W	2006
EM	3615771	 Terracotta (pantone 152)	16 35 41 42	Isenbruck bösl	E W	2006
EM	3616208	 Taubenblau RAL 5014	11 17 19	Poloplast GmbH	E	2007
EM	3646783	 Die Marke weist kontinuierliche Übergänge von einem Farbstreifen in einen anderen auf.. Rot, Orange, Pink	5 10 35 39 40 41 44	Weihermüller & Voigtmann	E W	2005
EM	3650769		20	Euro Pool system	E W	2006





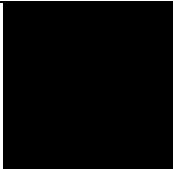

EM	3704194	 orange (Pantone 165), blue (Pantone 281) and white, which may vary in thickness and which are trailing off the page (without a set ending)	35 36	Ing. Groep N.V.	E W	2006
EM	3757473	 Grün / Green (Pantone 348C); gelb / yellow (Pantone 109C)..	4 37 39 43	BP p.l.c.	E R	2006
EM	3766508	 Blau Pantone 314	3	Zino davidoff	E W	2006
EM	3778669	 grün / green pantone 348C	4 37 39 43	BP p.l.c.	E W	2006
EM	3789407	 Pantone 9c cool gray	37	Audi AG	E W	2005
EM	3786423	 Pantone 186	37	AUDI AG	E W	2007
EM	3790235	 Celeste (the colour is halfway between Pantone 3248 and 3258 with an iridescent appearance)..	9 12 25	Cycleurope AB	E	2007
EM	3793361	 Purpur pantone 248C	31	Mars U.K.	E A	2007

EM	3806569	 gelb / yellow pantone 116C	9	KirbyMorgan Dive	E W	2006
EM	3818069	 Red and gold colour combination; Pantone yellow PMS nr 116; red PMS nr 032..	16 31	Zespri Group	E R	2006
EM	3818077	 . (Gold colour); Pantone colour specification PMS No. 116..	16 31	Zespri Group	E	2005
EM	3818085	 Bright green colour; Pantone colour specification unique colour, made from PMS yellow (34,8%), PMS green (12,1%), PMS white (51,6%) and PMS black (1,5%)..	16 31	Zespri Group Ltd	E W	2006
EM	3818093	 Light green/ dark green colour combination Pantone colour specification: light green - unique colour, made from PMS yellow (34.8%), PMS green (12.1%), PMS white (51.6%) and PMS black (1.5%); dark green PMS n° 3308	16 31	Zespri group ltd	E	2007
EM	3858602	 Gelb /yellow pantone process yellow	17	Siga Cover AG	E W	2006
EM	3858611	 Grün Pantone 376	17	Siga cover AG	E W	2006
EM	3858643	 Blau pantone 292	1 17	Siga Cover AG	E	2007
EM	3863891	 Pantone 226C	3	Reckitt Benckiser	E W	2006

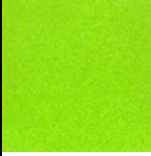





EM	3896883	 pantone warm red cool gray	7 8 9	Hans Einhell AG	E W	2006
EM	3916483		8	Fiscars oys	E W	2006
EM	3916616		8	Fiscars oys	E W	2006
EM	3934081	 violett	6 11 37	Braunach	E W	2006
EM	3939352	 Pantone PMS 186	18 25 28	Amer Sports GmbH	E W	2006
EM	3939386	 orangerot HKS 14	18 25 28	Amer Sports GmbH	E W	2006
EM	3947496	 Blau-RAL5017, schwarz-RAL9011	12	CNH Global	E R	2006
EM	3947512	 Blau-RAL5017, weiß RAL 9003, schwarz-RAL9011	12	CNH Global	E R	2006







EM	3955515	 Orange (pantone 165C) and powder blue (pantone 291C).	12 25 28 41	Gulf Oil Marketing	E R	2006
EM	3971273	 Enzianblau RAL 5010, Gelbgrün RAL 6018	4 35 37 39 43	OMV	E R	2006
EM	3982576	 Pantone RAL 2010	35	DAMAS Europe	E W	2006
EM	3985934	 Pantone 3005M (blau)	9 16 35 38 42	DSM Computer GmbH	E	2007
EM	3993071	 The colour combination red / yellow, for red; colour code pantone 485, for yellow; colour code pantone 137	36	Mastercard International Incorp.	E W	2005
EM	3999386	 Pantone process blue	10 16	Zimmer GmbH	E W	2006
EM	4028122		6 8 11 17 20 21	Krzysztof Pochyla trading as przedsiębiorstwo Wielobranżowe RAMP	E	2005





EM	4083119	 Black (corresponding to PMS Process Black), red (corresponding to PMS No. 1795)	5 29 30	Mars Inc.	E A	2007
EM	4083259	 Black (corresponding to PMS Process Black), red (corresponding to PMS No. 1795) and gold (corresponding to PMS 873)	5 29 30	Mars Inc.	E A	2007
EM	4083275	 The mark consists of the colour black (corresponding to PMS process black), as shown on the representation attached to the application, being the predominant colour applied to the whole visible surface of the packaging of the goods, the mark is not limited to the particular proportions nor the configuration of colour shown in the representation attached to the application	5 29 30	Mars Inc.	E W	2006
EM	4088431	 Braun / brown	8	Fiscars oyj	E W	2006
EM	4093431	 purpur (pantone 2855c)	9	Cadbury	E W	2005
EM	4093449	 purpur (pantone 2855c)	30	Cadbury	E W	2005







EM	4111415	 grün	12 18 25	Kawasaki motors	E W	2006
EM	4113189	 grün Pantone 372 C	3	Rosmarin kft	E W	2006
EM	4114187	 Fuschia (Pantone ton direct: 123; Pantone quadri: DS 128-4)	5 10	Bernard Chaffringeon	E W	2006
EM	4137618	 Pantone 137 C	9 37 38 41 42	TELEVES s.a.	E B	2007
EM	4183752	 Sonnengelb	9 16 41 42	Verlag neue Wirtschaftsbriefe	E W	2006
EM	4248399	 Türkis (Pantone 3135U)..	7 8 12 20	Gardena Manufacturing GmbH	E R	2007
EM	4261061	 rot pantone 485C	39	Hamburg Südamerikanische Dampfschiffartsges.	E A	2007

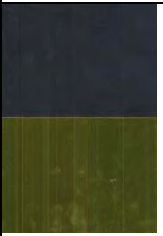





EM	4261889	 Enzianblau RAL 5010	9	Kraus & Neider	E	2007
EM	4262739	 pantone 2597	9 16	Coutts & CO	E W	2006
EM	4305603	 orange HKS 5	30	Kamps AG	E W	2006
EM	4305611	 HKS 5/ Pantone 4625	30	Kamps AG	E A	200/
EM	4313458	 schneeweiss	16	Ernst Marks GmbH	E W	2005
EM	4353694	 Zimtbraun PMS 726	16	Ernst Marks GmbH	E W	2006
EM	4353702	 Schneeweiss	16	Ernst Marks GmbH	E W	2006







EM	4353711	 Hellblau PMS 304	16	Ernst Marks GmbH	E W	2006
EM	4353728	 Hellbraun PMS 156	16	Ernst Marks GmbH	E W	2006
EM	4353736	 Kornfarben PMS 155	16	Ernst Marks GmbH	E W	2006
EM	4353744	 Braun PMS 140	16	Ernst Marks GmbH	E W	2006
EM	4353751	 Rosa PMS 197	16	Ernst Marks GmbH	E W	2006
EM	4353769	 Grün PMS 359	16	Ernst Macks GmbH	E W	2006
EM	4353777	 Goldgelb PMS 135	16	Ernst Macks GmbH	E W	2006





EM	4353793	 Gelb	16	Ernst Marks GmbH	E W	2006
EM	4353801	 Blau PMS 304	16	Ernst Marks GmbH	E W	2006
EM	4353819	 Grau (PMS Code 535)..	16	Ernst Marks GmbH	E W	2006
EM	4353835	 Gelblich-Weiß (PMS Code 7401)..	16	Ernst Marks GmbH	E W	2006
EM	4375481	 Grigio (Pantone standard 5C), e verde (Pantone standard 3268C)..	7 12	IMER International	E W	2006
EM	4392296	 Orange	20 35 38 39	TNT Holdings BV	E A	2007





EM	4400446	 Pantone colour no. PMS 278	8 9	Empire Level Manufacturing	E	2008
EM	4403151		16 24 25 28	TSV Alemania Aachen	E W	2007
EM	4409009	 Red rot Pantone 165 M	4	Aspen Petroleum AB	E W	2007
EM	4409066	 blue blau Pantone 300 M	4	Aspen Petroleum AB	E W	2007
EM	4454245	 Grau (Pantone 424 U), Orange (Pantone 021 C)..	7 8 9	Hans Einhell AG	E W	2007
EM	4479218	 Schwarz (Pantone black), Gold (Pantone 872/C)..	30	Barry Callebaut AG	E W	2006

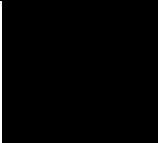



EM	4491247	 The colour red: Pantone 186C	35 36 39 41 42 43 44	Red letter days ltd	E W	2007
EM	4501813	 Blau, HJCO4R	6 9 11 17 19	E Hawle Armaturenwerke	E W	2007
EM	4532198	 Orange pantone 137C	8 16 34	Societe BIC	E W	2006
EM	4533683	 Enzianblau (RAL 5010)	35 39 40	Brenner Holding GmbH	E	2007
EM	4546628	 Pink	3	Reckitt Benkiser N.V.	E W	2006
EM	4578274	 green Pantone n° 368C	29 30	Lesieur	E W	2007

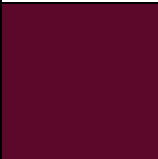
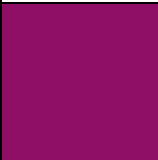

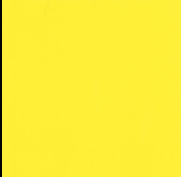

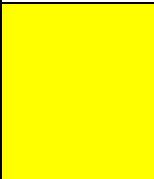

EM	4578721	 Orange, RAL 2010	7 35 42	A&M Electric Tools	E W	2006
EM	4587796	 Yellow Pantone PMS 107	30	WM Wrigleys	E W	2006
EM	4589388	 Pantone 306-307 (processblue)..	7	Dicar Inc	E A	2007
EM	4595294	 Gelb / grün	1 2 3 4 5 11 16 29 30 31 32 33 35 36 38 39 40 41 42 43 44	ZVIJEZDA d.d. za proizvodnju, trgovinu i usluge	E R O	2007
EM	4607801	 Rostorange, Gelb PY 42 (83,45%), Orange PO 67 (10,25%), Rot PR 112 (1,54%), Weiß PW 6 (0,26%).	7	KUKA Roboter GmbH	E A	2007
EM	4636676	 Magenta: Pantone Rhodamine Red U	35 36	Deutsche Telekom AG	E	2008





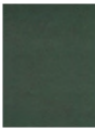
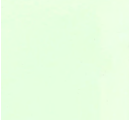

EM	2638177	 Blue Pantone 288 C; Yellow Pantone 7408 C	20 35	Inter IKEA Systems B.V.	R	2006
EM	4681375	 Red Pantone 032	1	Haifa Chemicals Ltd	E W	2006
EM	4694964	 rapsgelb RAL 1021	7 8 10	Ernst Vetter GmbH	E W	2007
EM	004720546		16	Brockhaus	E	2007
EM	004730925	 Ral 1028, Melonengelb (Pantone 137)..	34	Gizeh	E W	2007
EM	04802955		7 12	EXEL industries	E	2007







EM	4836094	 Zink-Gelb (RAL 1018); Schwarz (RAL 9005)	7	Alfred Kärcher GmbH	E	2008
EM	4870432		29 30	Bolton Alimentari	E W	2007
EM	4886388	 rose	16 20 21 37 42	Companie Plastic	E	2008
EM	4899233		16	RENOVA	E	2008
EM	4905709	 Gelb /schwarz yellow /black	34	Corporacion Habanos	E	2008
EM	5018023	 Violett	3	Reckitt Benkiser N.V.	E W	2007







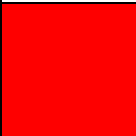

EM	5057377	 grün	16 31	ZESPRI Group	E W	2007
EM	5275840	 Pantone warm red	1 4 39	E.ON AG	E	2008
EM	5223136	 Bordeaux violett RAL 4004	3 7 24	Gert Eisenblätter GmbH	E	2007
EM	5251947	 Verkehrspurpur RAL 4006	3 7 24	Gert Eisenblätter GmbH	E W	2007
EM	5292669	 gelb / yellow RAL 1023	35	POCO Holding	E	2008
EM	5298989	 Gelb / Yellow RAL 1021	7	Jakob Maier	E O	2007







EM	5324157	 Rot / red RAL 3020	7	Hydrac Technology GmbH	E A	2008
EM	5397492	 grün / green RAL 6032	9	Leister Process Technologies	E O	2007
EM	5505251	 Applicant claims the color orange with the spectrophotometric coordinates L=76,21 a=15.66 b=87,02.	33	Mezzacorona sca	E W	2008
EM	5505342	 Applicant claims the color yellow with the spectrophotometric coordinates L=70,2 a=8,9 b=61,2.	33	Mezzacorona sca	E W	2008
EM	5522248	 Yellow / gelb Pantone PMS 142, green / grün RAL 6001	8	Franz Jost AG	E O	2008
EM	5671706	 Blue / Blau (Pantone 647 C), grey / Grau (Pantone 653 C)..	5	Orthomol pharmazeutische Erzeugnisse	E A	2008





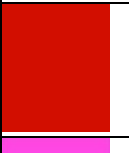
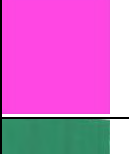

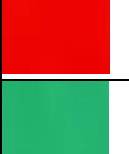

EM	5679584	 Brombeerrot ohne Struktur Pantone 7425 C.	31 42	Deurer Holding GmbH	E W	2007
EM	5679642	 Reinorange (RAL 2004).	5 10	Bioceuticals Arzneimittel AG	E W	2008
EM	5710595		6 7 17	Schaublin S.A.	E (W)	2008
EM	5805684	 Grün (Pantone 334).	7	WILO AG	E	2008
EM	5930896	 Grün / green (Pantone 5477C).	9	Varta AG	E	2007
EM	5983283	 Grün / green (NCS S 0510 G)..	17	BASF AG	E	2008
EM	5987524	 Colour RAL 6026 OPAL GREEN	7	Wesfalissurge GmbH	E	2008
EM	6258115	 Grün (Munsell 9.47 GY3.57/7.45); Gelb (Munsell 5.06 Y7.63/10.66)..	7 8 12	Deere & Co	E R	2008





EM	6258131	 Green (Munsell 9.47 GY3.57/7.45); yellow (Munsell 5.06 Y7.63/10.66).	7 8 12	Deere & Co	E R	2008
EM	6258156	 Green (Munsell 9.47 GY3.57/7.45); yellow (Munsell 5.06 Y7.63/10.66)	7 8 12	Deere & Co.	E R	2008
EM	6321384	 Orange (L=53,07, a=29,72, b=34,27)	7	Kuka Roboter GmbH	E W	2008
EM	6370456		16 36	Swiss Reinsurance Co.	E W	2008
EM	6372734		7 16 17 35	Trelleborg Sealing Solutions	E W	2008
EM	6406301	 rose	30	Bauli S.p.a.	E W	2008
EM	6468722		34 35 39 43 44	Federation international de logis	E A	2010





EM	6510226		21	Georgia Pacific Consumer	E	2010
EM	6519334	 Gelb / yellow	7 37 41	Backhus GmbH	E A W	2009
EM	6623251	 Orange (Pantone orange 021)..	9 10 21	Shield Scientific Holding	E	2010
EM	6696934	 Gelb / yellow	6	Gunnebo Industrie	E W	2009
EM	6728356	 Rot / red Pantone red 032.CMYK	16 35 36	Banco de Santander	E W	2009
EM	6817134	 gelb / yellow (pantone 151 C).	4 6 35 39	Repsol Butano	E W	2009
EM	6877476		31	Stube GmbH	E W	2009

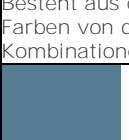

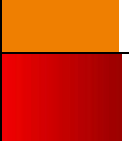
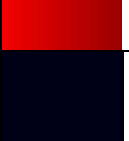

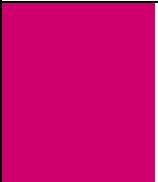

EM	6958144			7 9 11	Sytherm s.r.o.	E W	2009
EM	6974471	 Rot / red (Pantone 1795)		21	F.A.C. FABBRICA ALBISOLESE CERAMICHE S.P.A.	E W	2009
EM	6989024	 Rot / red (Pantone 200C)		30	Eridania Sadam	E W	2009
EM	7095193			9	Peter Hirt	E W	2009
EM	7114011			17	Vallorech & Mannesmann Tubes	R	2009
EM	7340656			35	Media Saturn	E W	2009
EM	7415912			7 8 9 21	Leifheit	E W	2009
EM	7490519			28	ALDILA	E W	2009







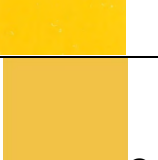
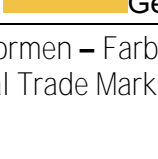

EM	7557408			20	IREGA AG	E W	2009
EM	8204786			34	B. V. Micres	E W	2009
EM	8322901			1 6 11 17 19	Alp Technology	E W	2009
EM	8391518			20	G. Eleftheriadis	E W	2010
EM	8409419			3 5 10 21 35 44	Profimed s.r.o.	E	2010
EM	8441693		Grün (HKS 53, Pantone Green)	11 16 20 21	Hansgrohe	E A W	2010
EM	8666042			7 8 9	Miller manufacturing	E	2011
EM	8666182			7 8 9	Miller manufacturing	E	2011

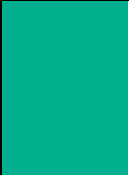



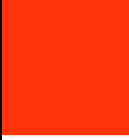



EM	8666349		7 8 9	Miller Manufacturing	E	2011
EM	8683633		9 38 42	O2 Holdings	E R	2010
EM	8690174		38	Telefonica S.A.	E	2011
EM	8690182		38	Telefonica S.A.	E W	2011
EM	8690191		38	Telefonica S.A.	E	2011
EM	8690208		9 35 38 41	Telefonica S.A.	E A	2013
EM	8795171	 <small>Copyright © 10/10/2010</small>	6	TATA Steel uk	E W	2010
EM	8845539		25	Christian Louboutin	E A	2011



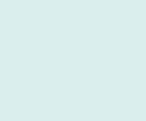



		La marque consiste en la couleur rouge (code Pantone n°18.1663TP) appliquée sur la semelle d'une chaussure telle que représentée (le contour de la chaussure ne fait donc pas partie de la marque mais a pour but de mettre en évidence l'emplacement de la marque).				
EM	08928533		9 16 25 2838 41 42	Miniclip S.A.	E W	2012
EM	8952376		7	Claas KG	E W	2012
EM	9053463	 Besteht aus der im Muster dargestellten Farbkombination und ist an sich eine Abstufung von Farben von dunkelblau (CMYK-Kombinationen C97 M97 Y45 K56), über mittelblau (CMYK-Kombinationen C85 M50 Y6 K2) zur Farbe Hellblau (CMYK-Kombinationen C46 M9 Y2 K3).	9 35 36 37 38 39 41 42 43 44	02 holdings ltd	R	2010
EM	9076209		17	Unidelta S.p.a.	E W	2012
EM	9084591		6	Pewag Austria	E W	2012
EM	9195439		9 11 20	High Tech Vision S.A,	E W	2012
EM	9417312		30	Perfetti van Melle	E W	2012

EM	9543927			12 20	Hazet Werk	E R	2012
EM	9585613			7 9	Chervon Ltd	E W	2011
EM	9660853		magenta	1 5 30	cristalco	E W	2011
EM	9705328			29	Parmalat	E W	2011
EM	10028827			7	Grundfos	E W	2011
EM	10090876			29 30	Jean Henaff	E W	2012
EM	10194835			7	Grundfos	E R	2015



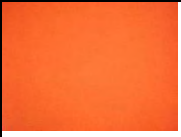
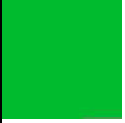

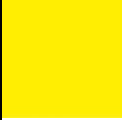

EM	10286011	 Grün (Pantone 362 U).	9	Phoenix Contact	E W	2012
EM	10341253	 grün / green	16 41 42	Deutsche Vereini-gung für gewerb-lichen Rechtsschutz und Urheberrecht e.v	E W	2012
EM	10368165		16	2 Gamma Srl	E W	2012
EM	10386191	 gelb / yellow	17 19	iMPREG GmbH	E A	2013
EM	10550317		11	Easy Sanitary Solutions B.V.	E W	2013
EM	10961076		31 35 44	Handelskwekerij Roma B.V.	E	2013
EM	11188786		9 16 25 28 35 37 38 41 42	Fastweb S.p.a.	E W	2013
EM	11283843	 Gelb / yellow	7 11	Technoalpin A.G. S.P.A.	E W	2013





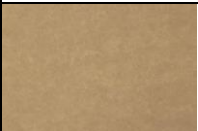

EM	11381341			9 42	Rembe GmbH	E W	2013
EM	11415825		Gelb / yellow	25	One way sport OY	E W	2013
EM	11494432		Blau / blue "pantone 280	21 32	AGUAS DE SOLAN	E W	2013
EM	11593035		orange "Pantone 172 C	12 35 37	TROST AUTO SERVICE	E W	2013
EM	11620424		Orange "RAL 2004	8	Deville	E W	2013
EM	11697174			7	Lely Patent N.V.	E W	2013
EM	11708377		Orange RAL 2009	8	Deville	E W	2013
EM	11709896		Pantone 376 C" grün./ green	9 37	Oxone Electronics	E W	2014

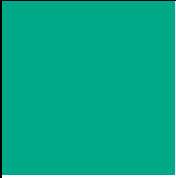

EM	11852291			6 8	RUD Ketten Rieger & Dietz	E W	2013
EM	11886777	 Erikaviolett ("RAL 4003"), "L =63,9, a =53,7 und b = -13,0 im CIE L*a*b". (verkehrsdurchgesetzt / secondary meaning)		6 7 8 9	RUD Ketten Rieger & Dietz	E A R	2015
EM	12001591	 Hellblau / light blue		16	Taiwan HOPAX	E W	2013
EM	12009304			16 35 41	Marqrt Holding	E W	2013
EM	12077641	 Blau / blue (Pantone 293)		1 12 37	Continental Teves AG	E W	2014
EM	12097168	 Gelb Yellow "Pantone 113".		35 36 37 42	Savills plc	E W	2013
EM	12103891			30	Van Dijk	E W	2013
EM	12206991	 Blau / blue "RAL 5011".		7	EREMA ENGINE-ERING RECYCLING Maschinen und Anlagen Ges bmH	E W	2014





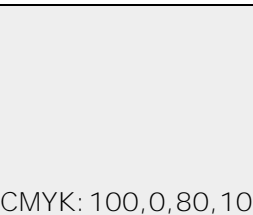

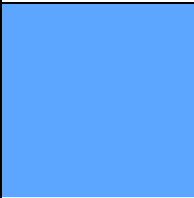
EM	12255204	 Ozeanblau / Ocean blue "RAL 5020 / Pantone 3165"	6	J. D. Theile GmbH & Co	E W	2014
EM	12329661	 Orange ("Pantone 1655")	19	Savona Speciality	E W	2015
EM	12549218	 Gold "PANTONE:7527 PC"; Weiss/White "PANTONE:11 4800 TPX".	9	K K Toshiba	E A	2017
EM	12831962	 Orange ("Pantone 1655")	9 35 44	Grandvision	E W	2014
EM	12886677	 Grün / green (RAL:6038)"	9	Bornack GmbH & Co. KG	R	2014
EM	013274196	 orange / Orange "(RGB:230,138,46)"	6 7 35 37 40	Combi Wear Parts AB	E W	2015
EM	13424742	 gelb / yellow"PANTONE:YELLOW C"	34	Flamagas	E W	2015
EM	13432951	 stahlblau Steel Blue "(PANTONE:5405 C)".	17	Elysee Piping	E W	2015

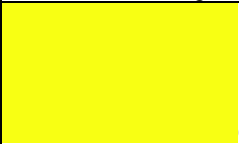
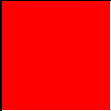
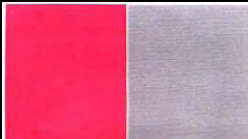



EM	13593553	 schwarz / black "RAL 9005"	9	Cagogas GmbH	E W	2015
EM	013852215	 Ultramarinblau / ultramarin blue (RAL:5002)	7 9 11	ZIEHL-ABEGG SE	E A W	2017
EM	014102123	 rot / red RAL 3003	7 8 37	Van Berkel Int.	E W	2016
EM	014275267	 Pastel orange / Pastellorange "(RAL:2003)	9	Huf Hulsbeck & Fürst	E W	2016
EM	014342075	 Pflaume / Plum "(PANTONE:5115C)	2 3 4 6 11 16 18 20 21 24 26 27 28 35 37 39	Victoria Plum	E W	2017
EM	014408934	 pine tree green / Kieferngrün (RAL:6028)	7	Manroland web systems GmbH	E W	2016
EM	014580948	 bordeaux (RGB:178,1,90)	10 20 24	Bekaert Textiles NV	E W	2016
EM	014596951	 lila /lilac PANTONE:2587C	5 10	Glaxo Group Ltd	E O	2017





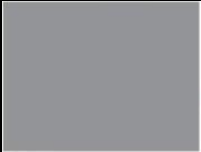

EM	014771497	 rot / red PANTONE:185C	6 20 39	L.P.R. La Palette Rouge	E W	2016
EM	015335681	 rosa / Pink "RGB:233,97,120".	44	SiCap Healthcare	E W	2017
EM	015410442	 Rot / Red(PANTONE:485C).	17	Policart S.r.l.	E A	2017
EM	016266827		16	Stora Enso Oyj	E W	2018
EM	016361032		12	Torqueedo	E A	2018
EM	016412884		2 18 20 21 24 25 27 42	Sarah Lavoine	E W	2018
EM	016556508		5	Merck KGaA	E W	2018
EM	016617391	 Hex #e60078	6	ASME Electricity	E W	2017



EM	017310426		Pantone Green C	10	B Braun Melsungen	E W	2018
EM	017436486		Pantone 2028C	3 35 41	Editions de Parfums Ltd	E A	2019
EM	017458951		Pantone 810	35 43	AZAGRA Patentes Y Marcas	E A	2019
EM	017492372		Pantone 389C	35 43	Marcas Geniales	E W	2018
EM	017541004		Pantone 212C	9 14 16 18 21 24 25 28 35 41 43	Stade Francais	E W	2018
EM	017567141			9 11 37 40 42 45	Wagner Group	E	2019
			grün / green CMYK: 100,0,80,10				

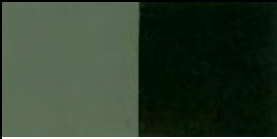

EM	017734633	 Blau / blue ptone 301	34 35 41	Avoria	E	2019
EM	017883536	 Pantone 2381	30	Biback Zwieback	E W	2018
EM	017897789	 Pantone 677C	10	Koninklijke Philips	E	2019
EM	01794928	 Cyan (cyan	16 18 28	Incall SpA	E	2019
EM	017992696	 Gelb / yello pantone F8FF11	35 41	Ericius Inventments	E	2019
ES	2571432		??	??	E W	2006
FI	208141		9 16 36 37 38 41 42	Deutsche Telekom AG	R	1997



FI	220696	 blue / blau Pantone 280 C	30	Oy Karl Fazer AB	R	2001
FI	227503	 Orange NCS S1080-Y40R	8	Fiscars OY	R	2003
FR	1538843	 rot / schwarz / weiss	16 35 36	Société Générale	R	1989
FR	95569168	 Orange Pantone 137C	8 16 34	SocieteBIC	R	1995
FR	9558173		3 24 25 27 35	Laura Ashley Manufacturing	R	1995
FR	98732057		4 37 39 43	BP p.l.c.	R	1998



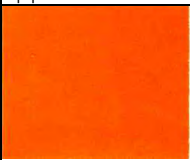

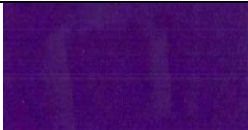

FR	00303864		1 3	Henkel France S.a.	R	2000
FR	003038764	 blau transparent / blue transparent	1 3	Henkel KG aA.	R	2000
FR	023166944	 Rhodanine: 45%, rubine red: 27%, noir rapida: 28%	16 20 32 33	Laurent Perrier	R	2002
FR	043268259	 The color(s) silver pantone 877 is/are claimed as a distinctive feature of the mark.	16	Henkel France S.A.	R	2004
FR	43297349	 <i>The mark comprises a shade of the colour blue, Pantone 296C</i>	7	Somfy	R	2004



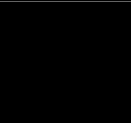



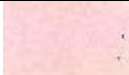

FR	053363728	 Vert Pantone n° 368C	29 30	Lesieur	R	2005
FR	05 3399099	 The trademark is composed of a square coloured orange (pantone 151).	9 38 42	ORANGE BRAND SERVICES LIMITED	R	2006
FR	05 3399097	 The trademark is composed of a square coloured orange (pantone 151).	9 38 42	ORANGE BRAND SERVICES LIMITED	R	2006
FR	06 3402843	 Gris pantone 417C et gris pantone 419C	7 9	Somfi sas	R	2006
FR	06 3414903		14 18 25 26	Christian Louboutin	R	2006
FR	06 34237714	 The mark consists of the colour yellow, as shown on the vignette, and corresponds to Pantone 1235C, the main colour applied on the visible part of wrappings or labels of the goods.	31	Masterfoods	R	2006
FR	07/34581905	 Process yellow / Prozessgelb	17 19	Saint Gobain Weber	R	2007





FR	08/3565649	 <p>Carmine red fading gradually to fuschia at the centre, then gradually to vermilion on the right. Carmine red (Pantone 228C), fuschia (Pantone 207C) and vermilion (Pantone 186C).</p>	9 12 16 18 24 25 28 35 36 38 39 41 43	S.N.C.F.	R	2008
GB	1	  <p>benutzt z.B. als / used e.g. as</p>	32	Bass & Co	R	1876



GB	1054549		Trade Mark consists of a colour blue applied to the surface of the cartridge container as indicated in the representation on the form of application	4	Application Des Gaz Société par Actions Simplifiée	R	1975
GB	2007850		The applicant claims the colour orange Pantone No 151 as an element of the mark.	9 38	Orange Personal Communication Ltd	R	1999
GB	2042556		über Verkehrsdurchsetzung / by secondary meaning Besteht aus der Farbe Lila, die als überwiegende Farbe auf der sichtbaren Oberfläche der Ware aufgebracht worden ist, die aus dem Muster ersichtlich The mark consists of the colour lilac, as shown on the form of application, being the predominate colour applied to the visible surface of the packaging for the goods	30	Kraft Foods Holding AG	R	1998
GB	2057893		Die Marke besteht aus der Farbe Orange Pantone 151 als vorwiegender Farbe, die auf die sichtbaren Oberfläche von Verpackungen und /	9 38	Orange Personal Communication Ltd	R	1996



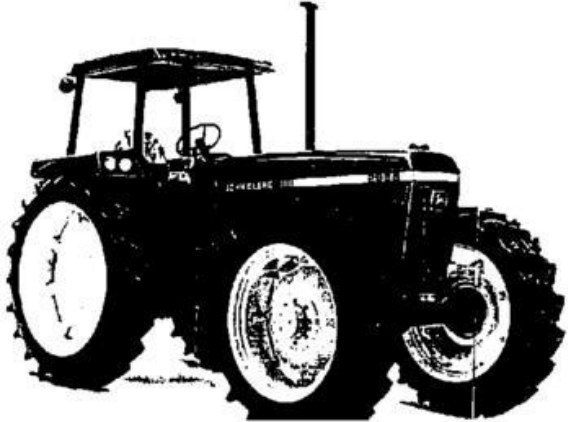

		oder Werbematerialien aufgebracht wird. (Verkehrsdurchsetzung). The mark consists of the color ornage pantone No 151 , beeing the predominant color applied to the visible surface of the pagaging and / or advertizing and promotional materials (Acquired distinctiveness).				
GB	2103551	The mark consists of the colour red, Pantone 485, as the predominant colour of the coloured surface of a passenger transport bus.	39	Transport for London	R	2000
GB	2126301	 Besteht aus der Farbe Purpur auf der Warenver-packung, wobei sich Farbe und Konfiguration aus der Anmeldung ergeben The mark consists of the colour purple as applied to the packaging of the goods, the colour and the configuration being as illustrated on the application form	30	Cadbury Ltd.	R	1999
GB	2239547	 used as  The applicant claims the colours green Pantone number 341C applied to the body of the cylinder, red/orange Pantone number 158C applied to the shroud, and white as a further element of the mark.	4	Calor Gas Ltd	R	2001

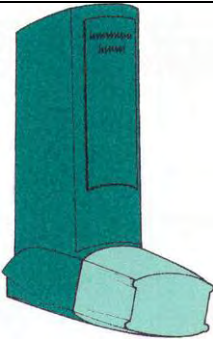

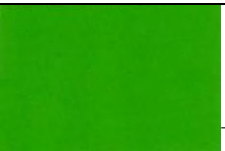
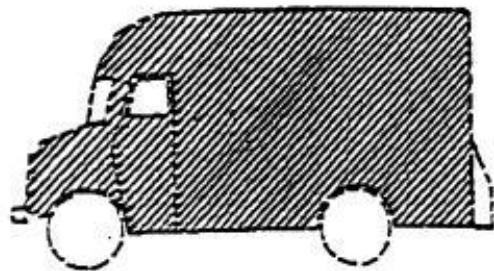

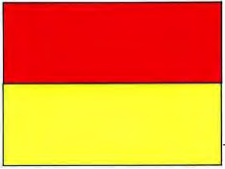

GB	2240552C		4 37 39 43	BP p.l.c	R	2000
GB	2360815A	 Pantone Black	33	Blavod Properties Limited	R	2004
HK	300352197	 the colours white, yellow, light green and green as elements of the trade mark	4 9 35 37 39 42	BP	R	2005
HR	Z20080825	 pink pantone 239C	3	Reckitt Benkiser	R	2010
HR	Z20092050	 magenta (RAL 4010 telemagenta)	38 42	Deutsche Telekom	R	2016
HU	165225		17	Owens Corning	R	2001
HU	194646	 magenta	9 38 42	Deutsche Telekom	R	2008
IT	693537	 La marque consiste à une empreinte rectangulaire dont les côtés verticaux sont séparés dans le sens horizontal en deux champs: celui supérieur de couleur blanche, celui inférieur de couleur orange	29 30	Ferrero S.p.A.		1996

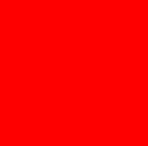

		orange (bottom)/ white (top)				
IT	719373		3 24 25 27 35	Laura Ashley Manufacturing	R	1997
IT	874299	 Yellow (pantone 130), blue (pantone 29)	36	INTESA SANPAOLO S.P.A.	R	2002
IT	948893	 Pantone 200c red / rot	30	ERIDANIA SADAM S.p.a.	R	2004
KR	4011837770000	 gold / golden	30	LIGO TRADING S.A. LX	R	2016
LT	44161	 green / white grün / weiss	21 25 26 41	VŠĮ "ŽALGIRIO KREPŠIN	R	2001
LT	44469	 brown / braun	39	UPS	R	2001
LV	M65229	 light green CMYK 30, 0 100 0	39	Baltic TAXI	R	2012
LV		 light green CMYK 30, 0 100 0	39	Air Baltic Corp.	R	2016



NO	226920	 Pantone colour "Warm Red C"	34	John Player & Sons Ltd	R	2005
NO	201607202		5 10	Glaxo	E	2017
NZ	220103	 The trade mark consists of a green colour applied to the body of the tractor, a yellow colour applied to the wheels of the tractor and a yellow colour applied in horizontal stripes to the sides of a tractor, as shown in the representation attached to the application form.	12	Deere & Company	R	1992
NZ	256793		4	Shell New Zealand	R	1997

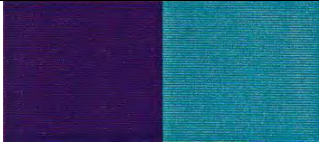

NZ	263753	 <p>colours dark green and light green, applied to the visible surface of inhalers</p>	10	Glaxo Group Ltd	R	1999
NZ	285611	 <p>The mark consists of the colour purple as shown in the swatch attached to the application, used on or in association with the goods.</p>	30	Cadbury Inc	R	2000
NZ	294930	 <p>The mark consists of the colour green (PMS 361C) as shown in the representation attached to the application, as applied to the packaging or promotional material used on or in association with the goods</p>	30	Soc. De Produits Nestle	R	2002
NZ	300375	 <p>The mark consists of the</p>	39	United Parcel Service	R	2002



		colour brown applied to the exterior surfaces of vehicles used for the supply of the said services as covered in the application.				
NZ	309521	 <p>The mark consists of the colours red (close to or being PMS Warm Red) and yellow (close to or being PMS Yellow 012) as shown on the representation attached to the application</p>	41	Surf Life Saving New Zealand Inc	R	2001
NZ	607441	 <p>The mark comprises the colours cream (Pantone Cream 100C) and blue (Pantone Reflex Blue C) as shown in the representation attached to the application</p>	30	Soc. De Produits Nestle	R	2002
NZ	609638	 <p>The trade mark comprises the colour peach for filters, filter socks and filter sleeves, used with animal milking apparatus and equipment as exemplified in the sample of filter bag material attached to the application form.</p>	11	AUSTRALIAN CATERING EQUIPMENT PTY LTD	R	2001
NZ	609757	 <p>The mark consists of the colour yellow (PMS 116 when printed upon coated paper, and PMS 109 when printed upon uncoated paper), as shown</p>	9	National Geographics	R	2002

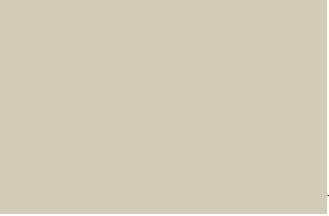

		in the representation attached to the application.				
NZ	611312		39	TNT Holdings BV	R	2002
NZ	615104	 The mark consists of the colour pink (Pantone No. 1767) applied to the goods as shown on the representation attached to the application, and the colour pink (Pantone Nos 204 and 213) applied to the packaging for the goods.	17	Owens Corning Corp.	R	2002
NZ	622338	 The mark consists of the colour medium brown as shown in the representation attached to the application	39	United Parcel Servie	R	2003
NZ	639043	 The mark consists of the colour yellow (Pantone 012) as shown in the representation attached to the application.	6	HYDRAULINK FLUID CONNECTORS LIMITED	R	2002
NZ	639476	 The mark is limited to the colours deep ocean green (PMS 3035 c) and red (PMS 485 c) as shown in the representation attached to the application.	1	Caltex	R	200
NZ	651134	 The trade mark consists of the colour yellow (Pantone 123) as represented on the application form, the trade mark being adopted as the	5	Schering Plough	R	2000







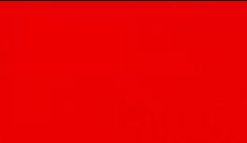

		predominant colour of an external surface or the external surfaces of packaging used in relation to the goods specified in the application form.				
NZ	657521	 <p>The trade mark consists of the colours Blue (RGB 14/49/146, CMYK 100/7/0/0) and Turquoise (RGB 1/156/177, CMYK 100/0/15/0), as shown in the representation attached to the application and as applied to the exterior and interior of buildings, and on promotional, marketing and advertising materials and on web pages; all being used in relation to the supply of the specified services</p>	35	Mag & Turbo Warehouse Franchises Limited	R	2003
NZ	665511	 <p>The mark consists of the colour green, Pantone 354, as illustrated on the accompanying swatch, used in association with the goods set out in the specification.</p>	36	Lloyds Bank	R	2003
NZ	666094	 <p>The mark comprises the colour blue as the predominant colour, in combination with the colours yellow and red applied to the exterior of vehicles, to the exterior surfaces of buildings, to signage boards and to webpages where the vehicles, buildings, signage and webpages are all used to the provision of services covered by this application</p>	35	FREEHILLS CARTER SMITH & BEADLE	R	2003







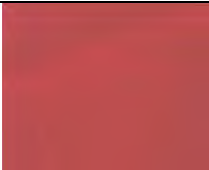

NZ	680612	 <p>The mark consists of the colours blue (Process Cyan), green (PMS 375) and yellow (PMS 116) as shown in the representation attached to the application and used in combination on the specified goods or on packaging for these goods</p>	9	Telecom IP New Zealand	R	2004
NZ	706440	 <p>The mark consists of the colour purple (CMYK: cyan 40%, magenta 100%), as shown in the representation attached to the application, applied as the predominant or predominant background colour to the packaging of the specified goods, and applied as the predominant or predominant background colour to the advertising or promotional material used in relation to the specified goods.</p>	31	Mars	R	201
NZ	800174	 <p>The mark consists of the colour blue (PMS Process Blue), as shown in the representation attached to the application, as applied to the exterior and interior surfaces of buildings and signage, and to printed matter and stationery, promotional advertising including internet advertising, TV advertising, advertising in newspapers, magazines, posters, brochures and other bank stationery, all being for the provision of the specified services</p>	36	ANZ Bank New Zealand	R	2012
NZ	801503	 <p>The mark consists of the colour beige (Munsell</p>	12	Crown Equipment	R	2012



		notation no. 3.9Y 7.12/1.4), which is a close approximation of Pantone 7534 or RGB No. 208 204 184, as shown in the representation attached to the application, as applied to the majority of the outer surfaces of the goods.,				
NZ	802521	 <p>The mark consists of the colour pink (Pantone 169C), as shown in the representation attached to the application, as applied to the exterior surface of the goods.</p>	10	Peach Teats Ltd	R	2012
NZ	855310	 <p>The mark is limited to the colour pink, (Pantone 677C) as shown in the representation attached to the application, applied to the exterior surface of the goods.</p>	10	Ceramtec GmbH	R	2015
NZ	965532	 <p>The mark consists of the colour maroon (PMS 195) as shown in the representation attached to the application as the predominant colour applied to the surface of the goods</p>	9	Trojan battery Inc	R	2015



NZ	1012864	 <p>The mark consists of the colour Green, (Nova Kiwibank Green; RGB: R102 / G204 / B51, CMYK: C58 / M0 / Y80 / K0), as shown in the representation attached to the application, as applied as the predominant colour to the interior and exterior surfaces of buildings and signage, all used for the provision of the specified services, or as applied as the predominant colour to the goods included within the application, said goods being for the provision of or for the promotion of the specified services, or as applied as the predominant colour to advertising materials or promotional marketing material including websites, internet advertising, mobile apps, other digital marketing, TV advertising, advertising in newspapers, magazines, posters, brochures and other printed materials, all promoting the provision of the specified services.</p>	36	KIWIBANK	R	2015
NZ	1031542	 <p>The mark is the colour Magenta (CMKY: C0 / M100 / Y0 / K0; RGB: R226 / G0 / B122; Websafe RGB: #0099) as shown in the representation attached to the application, applied to: the exterior and interior surfaces of buildings and signage, exhibition signage, vehicle signage, uniforms of staff and volunteers delivering the specified services, websites and intranet, printed matter and stationery, promotional goods, promotional advertising including internet advertising, TV advertising, advertising in newspapers, newsletters and magazines, posters, brochures, all being for the provision of the specified services</p>	45	IHC New Zealand	R	2017

NZ	1053188	 The mark is the colour Magenta (CMKY: C0 / M100 / Y0 / K0; RGB: R226 / G0 / B122; Websafe RGB: #0099) as shown in the representation attached to the application, applied to: the exterior and interior surfaces of buildings and signage, exhibition signage, vehicle signage, uniforms of staff and volunteers delivering the specified services, websites and intranet, printed matter and stationery, promotional goods, promotional advertising including internet advertising, TV advertising, advertising in newspapers, newsletters and magazines, posters, brochures, all being for the provision of the specified services	36	IHC New Zealand	R	2017
PL	206238	Red / rot	30		E A W	2007
PL	IR 667827	 La marque consiste à une empreinte rectangulaire dont les côtés verticaux sont séparés dans le sens horizontal en deux champs: celui supérieur de couleur blanche, celui inférieur de couleur orange	29 30	Ferrero S.p.A.	E A W	2006
RO	?	 The mark consists of the colour medium brown as shown in the representation attached to the application	39	UPS	R	2004
RU	238780		9 38 41	Deutsche Telekom	R	2003

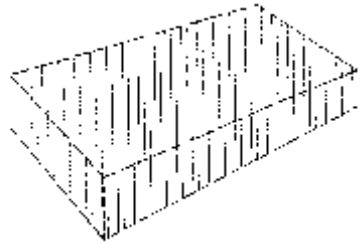
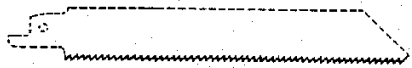

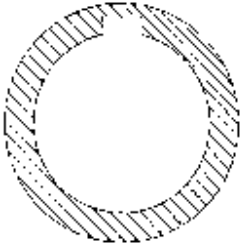
RU	310048			9 38 41	Deutsche Telekom	R	2006
RS	50572			4	BP	R	
SE	316716	 magenta / grey		9 16 36 37 38 41 42	Deutsche Telekom	R	1996
SE	372136	 lilac / lila (PMS 2613)		30	Aktiebolag Anders Löfberg	R	2005
SE	393645	 orange Pantone 805-C		6	Exte Fabrics AB	R	2008
SG	T0020666E			38	Deutsche Telekom	E	2015
SG	T9900634E	 Color green applied to containers or liquid petroleum gas		4	BP	R	200
SL	Z-201670446	 orange (pantone 159C)		29 30 35	DROGA KOLINSKA,	R	2016
TK	2004/36350			1 3 5	RECKITT BENCKISER	E W	2007

TK	2004/40402		18 25	Guccio Gucci S.P.A	E R	2005
TK	2004/40403		18 25	Guccio Gucci S.P.A	E R	2005
TN	2009/1756	 orange	9 38 42	Orange Brand Services Ltd	R	2010
UA	15408		9 38 41	Deutsche Telekom	E R	2000
UA	15407		9 38 41	Deutsche Telekom	E R	2000
UA	66406	 red	16	Приватне акціонерне товариство «Юридична практика» (UA)	R	2006
UA	74157	 pink	3	Reckitt-Benkiser	R	2007
UA	127798	 greyblue	17	Unidelta S.p.A.	R	2010
US	1439132	THE DRAWING IS LINED TO INDICATE THE COLOR PINK	17	Owens Corning Fiberglas	R	1987

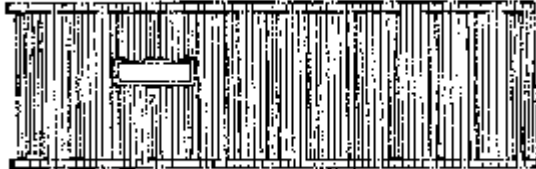
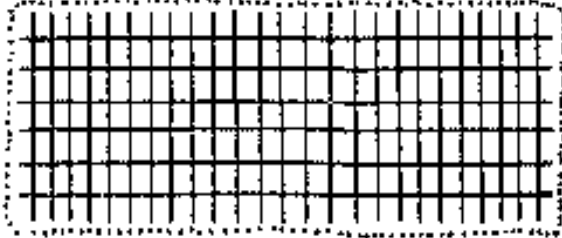

				Corp.		
US	1456144	 THE MARK CONSISTS OF THE COLOR WHITE AS APPLIED TO RECIPROCATING SAW BLADES	7	Irwin Industrial Tool Co.	R	1987
US	1633711	 The mark consists of a particular shade of green-gold applied to the top and side surfaces of the goods. The representation of the goods shown in phantom lining not a part of the mark and serves only to indicate position. / grün-gold	7	Qualitex Company	R	1991
US	1670247	 THE MARK CONSISTS OF THE COLOR GREEN WHICH IS COEXTENSIVE WITH THE OUTER SURFACE OF THE GOODS. THE PHANTOM LINES MERELY REPRESENT THE POSITION OF THE MARK ON THE GOODS AND IS NOT A FEATURE OF THE MARK.	17	The Artus Corp.	R	1991

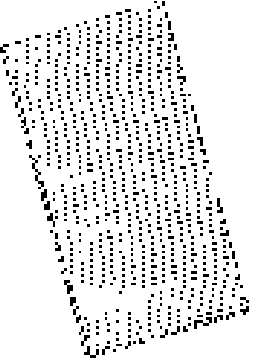
US	1774786	 <p>The mark consists of interdigitated spirals of color on the shaft of a golf club.</p>	28	Quest custom Golf Inc.	R W	1993 / 2000
US	1787869	<p>The mark consists of the color green as applied to ear cover domes of communication headsets. The configuration of a headset shown in dotted lines in the drawing is for illustrative purposes only and does not form part of the mark.</p> 	9	David Clark Company	R	1993

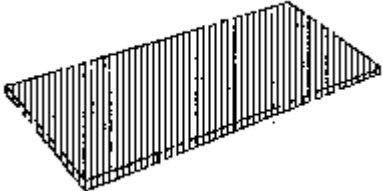
US	1841602	 <p>The mark consists of the color yellow on top of the color blue used on containers for the goods, the dotted lining reflecting the mode of use of the mark which is not limited to that particular container.</p>	2	WD-40 Company	R	1994
US	1874209	 <p>The mark consists of the color burgundy with a white rectangular decal as applied to a solid waste container. The container is not claimed as part of the mark.</p>	37 39	Waste management Inc.	R	1995
US	1905643	 <p>The mark consists of the color yellow which serves as a background color on the labels attached to the goods.</p>	19	Osmosr Inc.	R	1995

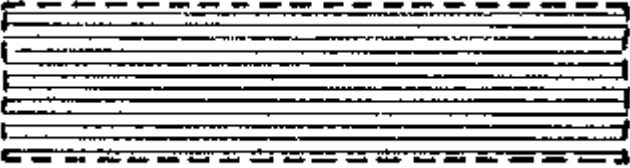
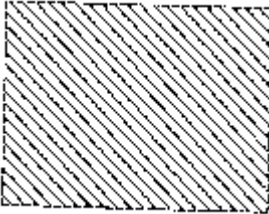
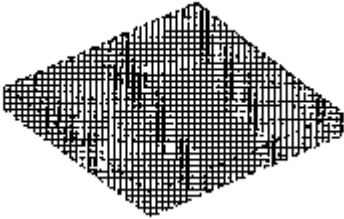

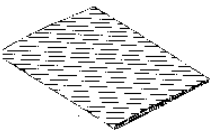
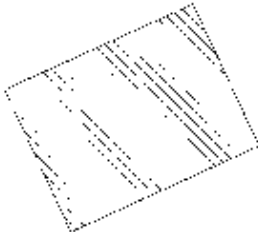
US	1931569	 <p>The matter shown by the dotted lines in the drawing is a configuration of the goods, is not a part of the mark, and no claim is made to it. The mark consists of the color blue used throughout the entirety of the goods.</p>	17	Dow Chemical	R	1995
US	2021137	 <p>The color yellow is a feature of the mark. The drawing has not been lined for yellow because of space limitations. The color yellow is in graduated form, being brightest at the top of the matrix, and fading as the matrix descends</p>	5	Johnson & Johnson	R W	1996 / 2002
US	2090588		17	Owens Corning	R	1997

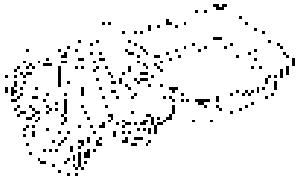
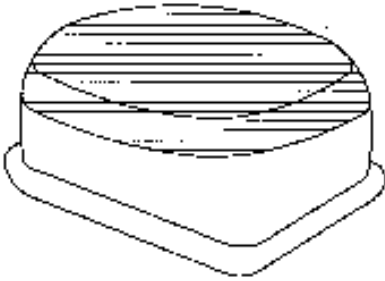

		The mark consists of the color pink as applied to the entirety of the goods. The dotted outline of the goods is intended to show the position of the mark and is not a part of the mark.				
US	2176916	 <p>The mark consists of the single color blue as applied to the entirety of the goods. The dotted lines merely indicate the position of the mark on the goods and do not form part of the mark.</p>	17	3 M Company	R	1998
US	2218775	 <p>The mark consists of the color green used over the entire surface of the goods. The matter shown in the drawing in broken lines serves only to show positioning of the mark and no claim is made to it. The drawing is lined for the color green.</p>	10	Magnerite Inc.	R	1999
US	2390667	 <p>The mark consists of the color canary yellow used over the entire surface of the</p>	16	3M Corporation	R	2000

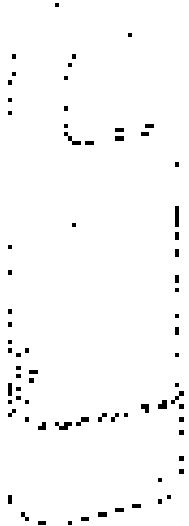
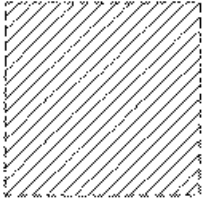



		goods. The matter shown in broken lines shows the position of the mark and is not claimed as part of the mark.				
US	2416794	 <p>The mark consists of a shade of blue often referred to as robin's-egg blue which is used on catalog covers. The matter shown in broken lines represents covers of various sizes and serves to show positioning of the mark.</p>	14	Tiffani LLC	R	2001
US	2503197	 <p>The mark is a quadrilateral with opposite sides parallel and equal. The mark is lined for the color green.</p>	9	Digi International	R	2001
US	2673478	 <p>The mark consists of the color dark green, excluding camouflage or olive drab, as applied to the entire casing of the goods.</p>	13	RA Brands LLC	R	2003

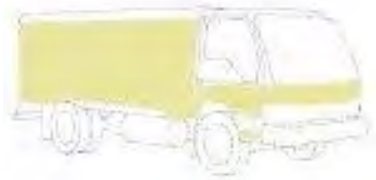



US	2678303	 <p>The mark consists of a four part egg style carton in the color purple. The broken lines in the drawing represent the position of the goods within the package and are not meant as part of the mark</p>	30	Kraft Foods Schweiz Holding	R	2003
US		 <p>The mark is comprised of a three-dimensional rectangular tablet, with rounded edges and rounded top, divided horizontally by color with the bottom layer colored in white and the top layer colored in blue. Color is claimed as a feature of the mark. The drawing is lined for the colors blue and white.</p>	1 36 10	Benkiser	R	2002



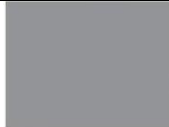

US	2740473	 <p>The mark consists of the colors green and brown. The drawing for the mark is lined for color as follows: the diagonal lining (in the direction from northeast to southwest) shown on the lower portion of the device indicates the color brown, and the diagonal lining (in the direction from northwest to southeast) shown on the remaining surface of the device indicates the color green. Color is claimed as a feature of the mark .</p>	5	Glaxo Group Ltd	R	2003
US	2901090	 <p>The mark consists of the color chocolate brown, which is the approximate equivalent of Pantone Matching System 462C, as applied to the en-tire surface of vehicles and uniforms. The mark consists of the color brown alone.</p>	39	United Parcel Service	R	2004
US	2942284	???????????????		The Black & Decker Corp.	R	2005







US	2950645	 <p>The mark consists of the color silver used on a bottle and the color black used on the cap of a bottle. The bottle is the packaging for the applicant's goods. The dotted lines in the drawing provide placement context for the mark, however, the shape of the bottle and cap are not claimed as a feature of the mark</p>	5	Oms Investments Inc.	R	2005
US	2984371	 <p>The mark consists of the color purple as applied to the entirety of the goods. The configuration of the coil spring is not part of the mark as shown</p>	12	Draco Spring Mfg	R	2005
US	3096959	 <p>The mark consists of the color red as applied to the outer and inner surfaces of the goods including in the thin middle concave circumference stripe.</p>	12	Clark Seals Ltd	R	2006





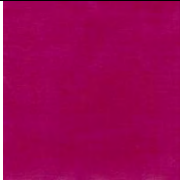

US	3097115	 <p>The color blue is claimed as a feature of the mark. The color blue appears throughout the mark as it is a part of the goods. The mark consists of the color blue as applied to the goods themselves. The broken lining in the drawing serves to show the position of the mark on the fabric goods and is not a part of the mark itself</p>	24	Linq Industrial Fabrics	R	2006
US	3123698	 <p>The mark consists of the yellow gold color called "Inca Gold" which is the approximate equivalent of Pantone Matching System 124 applied to the vehicles used to render the services.</p>	39	Swan's IP LLC	R	2006
US	3128225	 <p>The mark consists of the color dark blue with two congruent light blue stripes in a stylized wave design on the body of the helicopter.</p>	39	Helicopter Consultants of Mauri	R	2006







US	3153771	 The mark consists of a stylized design of a ribbon	35	Rational Animal	R	2006
US	3172669	 The mark consists of the color pink as applied to the entire surface of the goods, namely, gloves for medical and dental use, made of nitrile. The dotted outline of the goods is intended to show the position of the mark and is not a part of the mark	10	Top Quality manufacturing Inc.	R N	2006
US	3318419	 The mark consists of a square. The color red appears in the top portion of the square in the mark. The color black appears in the bottom portion of the square in the mark. The color white appears as a small horizontal line in the middle of the square in the mark	16 35 36	Societe Generale S.,A.,.	R	2007
US	3348719	 The mark consists of the color purple as applied to the entire surface of the goods	17	Vallourec & Mannesmann Tubes	R	2007



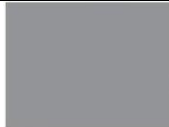



US	3376197	 The color(s) red is/are claimed as a feature of the mark. The color red appears in the design representing a stylized red sole.	18 25	Christian Louboutin	R	2008
US	79004508	 The color silver pantone 877 is claimed as a distinctive feature of the mark	16	Henkel	E W	2005
US	79007219	 The trademark consists of three stripes in the colors ORANGE (pantone 165), BLUE (pantone 281) and WHITE, which may vary in thickness and which trail off the page	35 36	Ing Groep N.V.	E W	2006
US	79033102	 blue / blau	6 9 11 17	E. Hawle Armaturenwerke GmbH	E W	2007
WO	548154	 Rot schwarz Weiss	16 35 36	Société Générale	R	1989



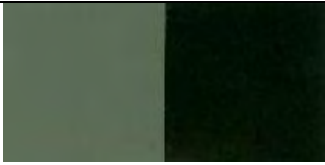



WO	644464	 Lila / Lilac	30	Kraft Foods	R	1995
WO	667827	 La marque consiste à une empreinte rectangulaire dont les côtés verticaux sont séparés dans le sens horizontal en deux champs: celui supérieur de couleur blanche, celui inférieur de couleur orange orange (bottom)/ white (top)	29 30	Ferrero S.p.A.	R	1996
WO	690863	 The Mark Consists of the Colour: Purple	29 30	Cadbury UK	R	1997
WO	707517	 Light blue and dark blue.	1 3	Reckitt Benckiser	R	1999
WO	716734	 orange weiss	1	Reckitt Benckiser	R	1999



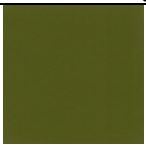

WO	717217			1	Reckitt Benckiser	R	1999
WO	719571A	 orange		30	Associated British Food plc	R	1999
WO	719571C	 orange		30	Associated British Food plc	R	1999
WO	744221	 Bungunderrot		30	Unilever	R	2000
WO	747563			1 3	Henkel France S.a.	R	2001
WO	747565	 grün durchsichtig / green transparent		1 3	Henkel France S.A.	R	2001
WO	767701	 Blau / Blue		29	Vandersterre Groep International B.V.	R	2001

WO	771164	 Light blue, azure blue, dark blue	29 30	Nestec Ltd	R	2001
WO	773375	 gelb / yellow	30	Unilever	R	200
WO	790404	 blue / blau	16 18	Henzo B.V.	R	2002
WO	791816	 Yellow (pantone 130), blue (pantone 29)	36	INTESA SANPAOLO S.P.A	R	2002
WO	794663	 RHODANINE: 45%, RUBY RED: 27%, RAPIDA BLACK: 28%	16 21 32 33	Laurent Perrier	R	2002
WO	800700	 türkis / turquoise	3	Henkel KGaA	R	2003
WO	811634	 pink (pantone 241)	3	Henkel KG aA	R	2004

WO	830934	 The color silver pantone 877 is claimed as a distinctive feature of the mark	16	Henkel DE	R	2004
WO	B838659	 The trademark consists of three stripes in the colors ORANGE (pantone 165), BLUE (pantone 281) and WHITE, which may vary in thickness and which trail off the page	35 36	ING Groep N.V.	R	2004
WO	852829	 The mark comprises a shade of the colour BLUE, Pantone 296C	7	Somfy	R	2004
WO	863506	 green / grün RAL 150 60 40	19	aquatherm GmbH Kunststoff-Extrusions- und Spritzgiesstechnik	R	2005
WO	881847	 RAL 4006 - Verkehrspurpur (purple).	17	Valloulourec & Mannesmann Tubes	R	2005
WO	890375	 MAGENTA: PANTONE RHODAMINE RED U	28 32 35 36 41 42	Deutsche Telekom AG	R	2005

WO	895094	 Gris pantone 417C et gris pantone 419C	7 9	Somfy sas	R	2006
WO	902955		14 18 24 25 26	Christian Louboutin	R	2006
WO	906298	 The mark consists of the colour yellow, as shown on the vignette, and corresponds to Pantone 1235C, the main colour applied on the visible part of wrappings or labels of the goods.	31	Masterfoods	R	2006
WO	908136	 The trademark is composed of a square coloured orange (pantone 151).	9 38 42	ORANGE BRAND SERVICES LIMITED	R	2006
WO	908137	 The trademark is composed of a square coloured orange (pantone 151).	9 38 42	ORANGE BRAND SERVICES LIMITED	R	2006
WO	909031	 blue / blau	6 9 11 17 19	E. Hawle Armaturenwerke GmbH	R W	2010

WO	912143	 Gentian blue RAL 5010 and yellow-green RAL 6018	4 34 36 37 39 43	OMV Aktiengesellschaft	R	2006
WO	915984	 Magenta RAL 4010 telemagenta	38 42	Deutsche Telekom AG	R	2006
WO	942069	 Pantone process yellow / prozessgelb	17 19	Saint Gobain WEBER	R	2007
WO	943432	 Grey / grau (Pantone 5487).	36	Swiss Reinsurance Company	R	2007
WO	946812	 green / grün	9	Varta Batterie	R	2007
WO	982273	 green / grün	16	Marcus Sommer SOMSO Modelle GmbH	R	2008
WO	1001828	 Carmine red fading gradually to fuschia at the centre, then gradually to vermilion on the right.	9 12 16 18 24 25 28 35 36 38 39 41 43	S.N.C.F.	R	2008

WO	1008834	 Pantone 200c red / rot	30	ERIDANIA Sadad s.p.a	R	2009
WO	1109076	 Pink (Pantone 677 C, edition 2010).	10	CeramTec GmbH	R	2012
WO	1320554	 orange (Pantone 159C)	29 30 35	DROGA KOLINSKA	R	2016
WO	1332480	 PANTONE 151 orange (Pantone 151)	30	kriokrush basic foods Pty. Ltd.	R	2016

*

W = zurückgezogen oder zurückgewiesen, withdrawn or rejected

R = eingetragen, registered

E = geprüft, examination

A = Beschwerde, Appeal

O = Widerspruch, Opposition

N = Löschung, Nullification