







Hologrammmarken / Hologram Device Marks

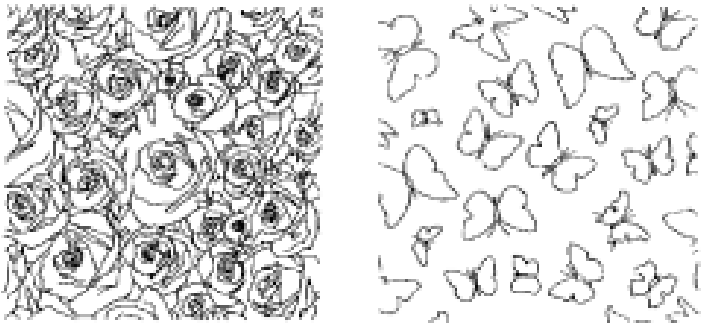
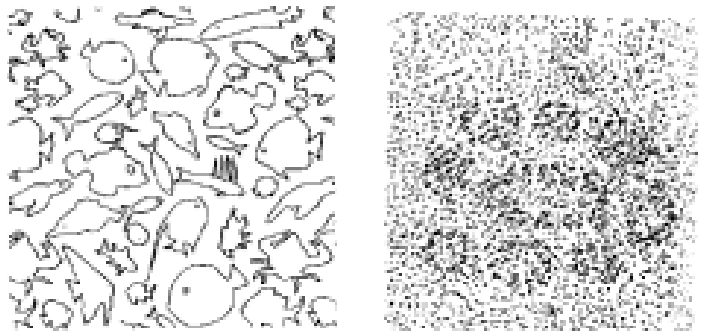

Land Country	Aktenz. Serial#	Marke Mark	Klasse Class	Anmelder Applicant	Status *	Check
AU	930971	 <p> COMBINED HOLOGRAPHIC VIEW FIRST HOLOGRAPHIC VIEW SECOND HOLOGRAPHIC VIEW </p>	22 24 25	Gulfstream Trading Co	E W	2004
CA	835927	 <p> The trade-mark consists of a hologram reflecting all colours, or any colour, of the light spectrum (an example of which appears in the graphic representation of the mark which is attached hereto and which forms part of this application) which is applied to the packaging of wares stated in the specification of wares. A formal drawing, the purpose of which is to depict the background design of the hologram, is attached hereto; the square shape shown in dashed outline does not form part of the trade-mark </p>	3	SmithKline Beecham	E W	2002

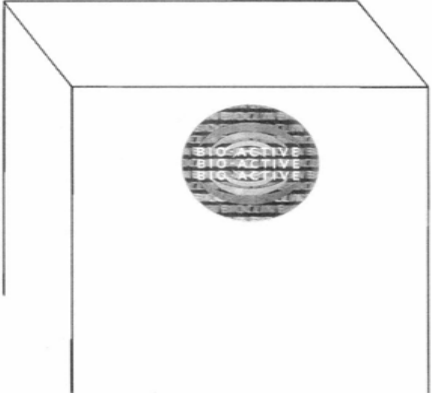
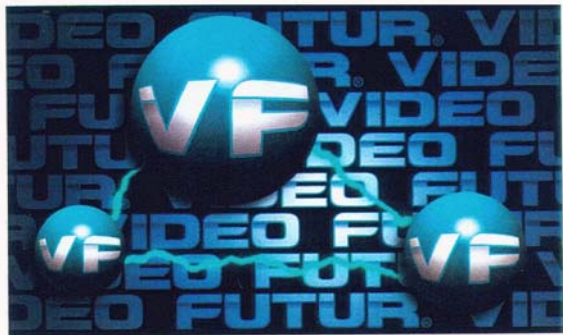

CA	1002075	 <p>The trademark consists of a hologram applied to the wares, and as viewed from one angle depicts a repeating pattern of roses, and from another angle a repeating pattern of butterflies, with these patterns being superimposed in whole or in part when viewed from still other angles. A graphic representation of the mark illustrating the separate repeating patterns is attached to form a part of the application</p>	18	JEANNE LOTTIE'S FASHION INCORPORATED	E W	2001
CA	1002079	 <p>The trademark consists of a hologram applied to the wares, and as viewed from one angle depicts a repeating pattern of fish, and from another angle a repeating pattern of coral, with these patterns being superimposed in whole or in part when viewed from still other angles. A graphic representation of the mark illustrating the separate repeating patterns is attached to form a part of the application.</p>	18	JEANNE LOTTIE'S FASHION INCORPORATED	E W	2001

<p>DE</p>	<p>30219764 24 W (pat) 102/03</p>	 <p>Gegenstand der Marke ist ein für Verpackungen von Eau de Toilette bestimmtes, konturenunbestimmtes Hologramm mit altrosé-farbener, metallisch-glänzender Grundfarbe. Bei Lichteinfall scheinen vertikale geradlinige Streifen in den Spektralfarben von violett über blau, grün, gelb, orange bis rot auf. Die Spektralfarbenstreifen weisen Abstände von je ca. 5 cm auf. Die silbrig-glänzende Oberfläche des Hologramms entspricht dem Farbton „Cool Gray 1 C“ des Farbsystems <i>PANTONE formula guide solid coated</i>. Für den roten Farbton findet „Process Magenta C“ des Farbsystems <i>PANTONE formula guide solid coated</i> in der Weise Verwendung, daß mit einem Farbauftrag in einem Raster von 70 eine Farbabdeckung von 30% erreicht wird. Wenn bei sonnigem Wetter der Gegenstand der Marke senkrecht (90° zur Horizontalen) in Augenhöhe des Betrachters im Freien plaziert wird und die Sonne hinter dem Betrachter steht, weisen die Spektralfarbenstreifen eine Breite von je 2 mm auf. Dabei ergeben sich bei verschiedenen Blickwinkeln – von links nach rechts – folgende, jeweils von oben nach unten stufenlos verlaufende Anordnungen von Spektralfarben: 30°: violett, blau, grün gelb; 60°: grün, gelb, orange, rot; 90°: orange, rot, violett, blau, grün; 120°: rot, violett, blau, grün, gelb; 150°: blau, grün, gelb, orange.“ The mark is a shapeless hologram for use as wrapping for eau de toilette with a rose metallic glittering base, the silver metallic glittering being cool grey 1C Pantone formula guide solid coating and rose being process magenta C Pantone formula guide solid coating. Upon action of light vertical rectilinear lines (about 5 cm) in the spectral colours violet, blue, green yellow and orange appear. The hologram is an embossed hologram wherein magenta is printed on the silver surface and then coated with a varnish. In case of sunny weather and when placing the wrapping perpendicularly to the viewer outside and the sun being behind the viewer, the lines of spectral colours have a width of 2</p>	<p>3</p>	<p>Parfum Christian Dior</p> 	<p>E A W</p>	<p>2005</p>
-----------	-------------------------------------------	----------------------------------------------------------------------------------------------------------------------------------------------------------------------------------------------------------------------------------------------------------------------------------------------------------------------------------------------------------------------------------------------------------------------------------------------------------------------------------------------------------------------------------------------------------------------------------------------------------------------------------------------------------------------------------------------------------------------------------------------------------------------------------------------------------------------------------------------------------------------------------------------------------------------------------------------------------------------------------------------------------------------------------------------------------------------------------------------------------------------------------------------------------------------------------------------------------------------------------------------------------------------------------------------------------------------------------------------------------------------------------------------------------------------------------------------------------------------------------------------------------------------------------------------------------------------------------------------------------------------------------------------------------------------------------------------------------------------------------------------------------------------------------------------------------------------------------------------------------------------------------------------------------------------------------------------------------------------------------------------------------------------------------------------------------------------------------------------------------------------------------------------------------------------------------	----------	------------------------------------------------------------------------------------------------------------------	--------------	-------------

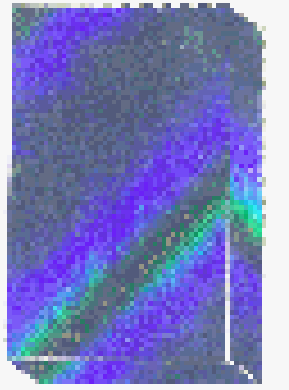

		mm. So the following arrangements of spectral colours arise depending on the different views: 30°: violet, blue, green, yellow; 60°: green, yellow, orange, red; 90°: orange, red, violet, blue, green; 120°: red, violet, blue, green, yellow; 150°: blue, green, yellow, orange. See right-hand side.				
DE	30453281	 <p>weiss, silber, orangegelb, blaugrün / white silver, orange yellow, bluegreen</p>	9 16	Nikon GmbH	R	2004
DE	30453263	 <p>weiss, silber, orangegelb, blaugrün / white silver, orange yellow, bluegreen</p>	9 16	Nikon GmbH	R	2004

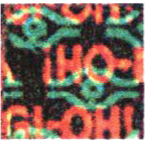
EM	1787456	 <p data-bbox="658 564 815 592">Bio – Active</p>	3 5	Bioclean B.V.	R	2003
EM	2117034	 <p data-bbox="1178 975 1335 1002">Video Future</p>	9 38 41	GDS Video	R	2002





EM	255914434	 <p>Die in der Anlage gezeigte Marke besteht aus holografischem Papier, das das Farbenspektrum in schrägen, parallelen Linien auf die Packungs-oberfläche reflektiert; die punktierten Linien auf der Zeichnung gehören nicht zur Marke und dienen nur der 3-D-Illustration.. Farbangabe : Das gesamte Farben-spektrum (Hologramm)..; The mark as shown in the attachment consists of holographic paper that reflects the spectrum of colour in a pattern of oblique, parallel lines applied to the surface of a package; the dotted lines shown in the drawing form no part of the mark, and are for 3-d illustrative purposes only.. Indication of colour : The whole spectrum of colour (hologram)..</p>	34	Eve Holding Inc.	R	2004
EM	2788362	 <p>Midland</p>	16 34 35	United Tobacco Corp.	E W	2005



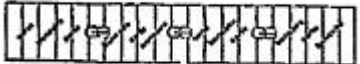

EM	2886083	 <p>The mark consists of a hologram in the shape of a square applied to the goods; the content of the hologram is not claimed as a feature of the mark; the drawing is lined for the colour gold or silver but colour is not claimed as a feature of the mark</p>	16 28	The upper deck Co	E W	2005
EM	2946556	 <p>Sea Island The mark</p>	22 24 25	Gulfstream Trading Company	E W	2005

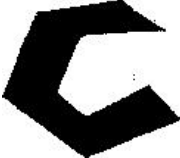

		consists of a hologram in the shape of a square applied to the goods; the content of the hologram is not claimed as a feature of the mark; the drawing is lined for the colour gold or silver but colour is not claimed as a feature of the mark. Die Marke besteht aus einem Hologramm				
EM	3908001	 <p>If the viewer inclines the hologram slightly to the left, depending on the incidence of light he will see the following shades: 1st.left wreath: green, yellow, red, circle: lilac, grey.If he turns it further to the left, depending on the incidence of light he will see the following shades: 2nd.left wreath: lilac, blue, circle: blue, lilac.If the viewer turns the hologram still further to the left, depending on the incidence of light he will see the following shades: 3rd.left wreath: dark lilac, circle: yellow/ blue.If the hologram is turned from the centre slightly to the right, depending on the incidence of light the viewer will see the following shades: 1st.right wreath: lilac, blue, circle: yellow, black.If he turns it further to the right, depending on the incidence of light the viewer will see the following shades: 2nd.right wreath: blue, grey, lilac, circle: grey, lilac, if he turns it still further to the right, depending on the incidence of light the viewer will see the following shades: 3rd.right wreath: yellow, red, green, circle: lilac..Neigt der Betrachter das Hologramm leicht nach links, so erkennt er jenach Lichteinfall die Darstellung in folgenden Farbnuancen: 1. links Kranz: Grün, Gelb, Rot, Kreis: Lila, Grau. Bei einer weiteren Drehung nach links nimmt der Betrachter je nach Lichteinfall folgende Farbnuancen wahr: 2. links Kranz: Lila, Blau, Kreis: Blau, Lila. Dreht der Betrachter das Hologramm noch weiter nach links erkennt er je nach Lichteinfall folgende Farbnuancen: 3. Links Kranz: Dunkellila, Kreis: Gelb/ Blau. Wird das Hologramm von der Mitte aus leicht nach rechts gedreht, so nimmt der Betrachter je nach Lichteinfall folgende Farbnuancen wahr: 1. rechts Kranz:</p>	16 17 40	Cass Laminierungs GmbH	E W	2005



		Lila, Blau, Kreis: Gelb, Schwarz. Bei einer weiteren Drehung nach rechts nimmt der Betrachter je nach Lichteinfall folgende Farbnuancen wahr: 2. rechts Kranz: Blau, Grau, Lila, Kreis: Grau, Lila, Bei einer weiteren Drehung nach rechts nimmt der Betrachter je nach Lichteinfall folgende Farbnuancen wahr: 3. rechts Kranz: Gelb, Rot, Grün, Kreis: Lila.				
EM	04518296	 <p>"GG" mit Globus bzw. Weltkarte in der Aussparung der "G"; der Schriftzug GLANZ & GLORIA steht in Großbuchstaben zentriert darunter. „GG“ with globe or map of the world, respectively, with the letter „G“, the language „Glanz & Gloria“ below the device.</p>	3, 14, 18, 23, 24, 25, 32, 44	Gloria Zittel	E W	2005
EM	04519468	 <p>"GG" mit</p>	3, 14, 18, 23, 24, 25, 32, 44	Gloria Zittel	E W	200/





		Globus bzw. Weltkarte in der Aussparung der "G"; der Schriftzug GLANZ & GLORIA steht in Großbuchstaben zentriert darunter.				
EM	5208095	 <p>The trademark is rectangular in shape with rounded edges and is placed on the product. The trademark will appear to shift and various elements will come into focus, alternatively disappear, as the viewer sees the mark from different angles. Elements include, but are not exclusively made up of, a circular shaped figure appearing to hold a round ball within, and the opening holding the ball being divided into two asymmetrical parts, by a curved stripe and the text sony ericsson in various shapes and sizes. Colour and elements will shift with light and angle of viewpoint and focus.. Rechteckige Form mit abgerundeten Ecken, wird auf der Ware appliziert, Marke verschiebt sich und verschiedene Elemente erscheinen oder verschwinden je nach Blickwinkel des Betrachters, zu diesen Elementen zählen unter anderem eine kreisförmige Figur mit einem runden Ball darin, die Öffnung hält den Ball, wobei dieser durch einen gekrümmten Streifen in zwei asymmetrische Teile geteilt ist, der Text sony ericsson in verschiedenen Formen und Größen, die Farben und Elemente variieren je nach Beleuchtung, Blickwinkel und Fokus..</p>	9 38	Sony Ericsson Mobile communications	E W	2007
FR	1 525 074	 <p>L'hologramme est constitué de rectangles successivement bleu et vert sous incidence perpendiculaire. Sous les autres angles d'incidence, les couleurs varient selon la loi $\lambda \cos i$ où λ est</p>	9 16 36	GROUPEMENT DES CARTES BANCAIRES	R	1989

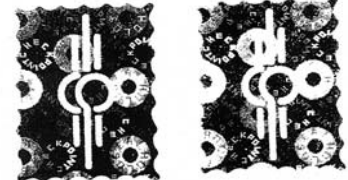

FR		<p>la longueur d'onde de la lumière et i l'angle d'incidence (en radians).</p>  <p>Marque comportant un hologramme Marke Mark comprising a hologram Hologrammenthaltende Marke</p>	9 16 36 38	GROUPEMENT DES CARTES BANCAIRES	R	1996
FR	96657860	 <p>NITYA</p> <p>hologram</p> <p>Marque comportant un hologramme. Mark comprising a</p>	3 24 25	Nitya sarl	R	1996
FR	99768498	 <p>Trademark consisting of a hologram</p>	25	Granereau	R	1999
FR	003072825	 <p>Marque déposée en couleurs; marque comportant un</p>	29 30 31	Generale traiteur	R	2000



		hologramme Mark filed in colour; mark comprising a hologram.				
FR	013087664	 <p>ÉLISE ACCOUTURIER <i>Lingerie</i></p> <p>Square made up of light pink and dark pink sections within a yellow frame made up of small suns, the trademark comprising a hologram. Carré fait de roses claires et roses foncées entouré d'un cadre jaune fait de petits soleils, la marque comportant un hologramme.</p>	25	Elise Aucourturier	R	2001
FR	033220578	 <p>HEAD-Balance</p> <p>La marque comporte un hologramme. The trademark comprises a hologram.</p>	10	Alfred Pfennig	R	2003
FR	033247255	 <p>COOL shoe corporation</p> <p>Mark comprising a hologram representing spectacles in the place of "OO"</p>	25	Granerreau	R	2003
FR	033259798	 <p>COOL Footwear</p> <p>Logo consisting of spectacles followed by the term "FOOTWEAR"; trademark comprising a</p>	25	Granerreau	R	2003



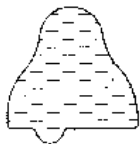
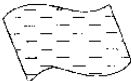
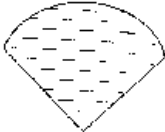

		hologram				
FR	053346093		16 21 24 30	D et S Sarl	R	2005
		Mark comprising a hologram; the vignettted green is the background colour; the logo in the shape of a gilded pear; the strip border in the form of a rectangular chain in gold.				
FR	053386430		16 25 38	LE RIDOU BONNAUDEAU Frédéric	R	2005
		Mark comprising a hologram - "NOT SLAVE".				
FR	063445514		25 28	Said Bouhmama	R	2007
		The trademark KOODBULL is a semi-figurative mark comprising a hologram reproducing a head butt; the principal colours are blue, white and red				

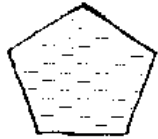
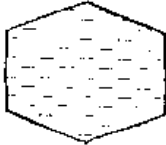
FR	073477283	 <p data-bbox="510 467 1429 563">Description de la marque : Nom de marque : " KOOD BULL " avec la première lettre " K " inversée. Slogan : " For respect ". Prononciation : " KOUD'BOUL ".</p> <p data-bbox="689 576 1240 603">KOOD BULL the letter K being written nversed</p>	16 25 28 35	Said Bouhmama	R	2007
GB	2031496		36	Checkpoint Security Services	W	2000
HU	154630		3 10 21	SmithKline Beecham p.l.c	R	1999

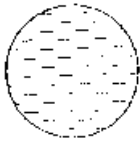
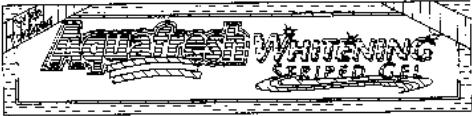

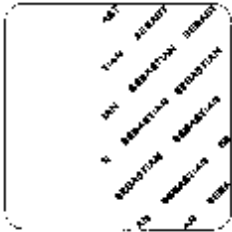
SE	1997/0117 1	 Hologram formed by a kaleidoskop varying picture depending on the light	3 10 21	SmithKline Beecham p.l.c	E	2007
SG	T0108194 C	 NITYA The mark consists of a simple hologram as shown in the representation attached to the application form.	03	Nitya sarl	E	2002
SG	T0108195 C	 NITYA The mark consists of a simple hologram as shown in the representation attached to the application form.	24	Nitya sarl	E	2002
SG	T0108196 C	 NITYA The mark consists of a simple hologram as shown in the representation attached to the application form.	25	Nitya sarl	E	2002



SG	T0318748 C	 <p>Seen from the top to bottom: color changes: the writing of the trademark logo turns blue except for the dash and the under line (the word „balance“ written in green turns blue, the red dash stays red, the yellow line under „head“ stays yellow)</p>	10	Alfred Pfennig	E W	2004
US	2143827		16	Rembrand Photo services	R	1997
US	2165006		16	Upper Deck Company	R W	2005
US	2165007		16	Upper Deck Company	R W	2005
US	2165008		16	Upper Deck Company	R W	2005

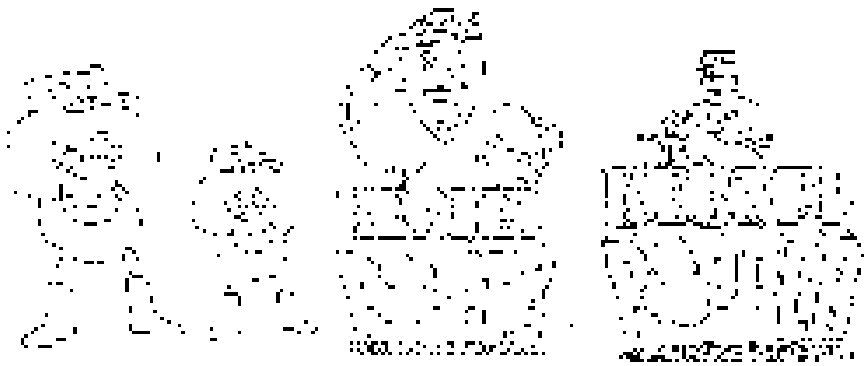
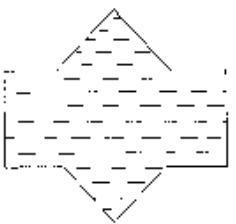

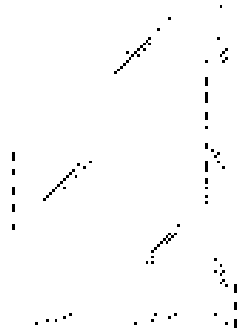
US	2177761		16	Upper Deck Company	R W	2005
US	2177762		16	Upper Deck Company	R W	2005
US	2177763		16	Upper Deck Company	R W	2005
US	2179830		16	Upper Deck Company	R W	2005
US	2278307	 Aquafresh Whitening ... Gel	3	SmithKline Beecham	R	1999

US	2288159		Kollektiv marke	Sebastian International	R	1999
US	2324607	 Aquafresh Whitening ...	3	SmithKline Beecham	R	2000
US	2324617	 Aquafresh Whitening ...	3	SmithKline Beecham	R	2000
US	2360979		16	Upper Deck Company	R	2000
US	2619227		16 28	Upper Deck Company	R	2003



US	76/388825	 <p>The mark depicting popped popcorn in a three-dimensional arrangement; three popped popcorn cartoon characters that move from the foreground to the background depending upon the angle one views the image; a cartoon man dressed in a military costume that changes into a popcorn cartoon character dressed in a military costume depending upon the angle that one views the box above the words "THE KERNEL POPPER MICROWAVE POPCORN".</p>	30	Kernel Vendors	E	2005
US	2710652		16	Upper Deck Company	R	2003

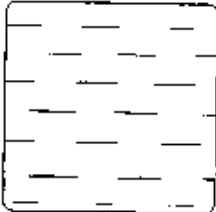

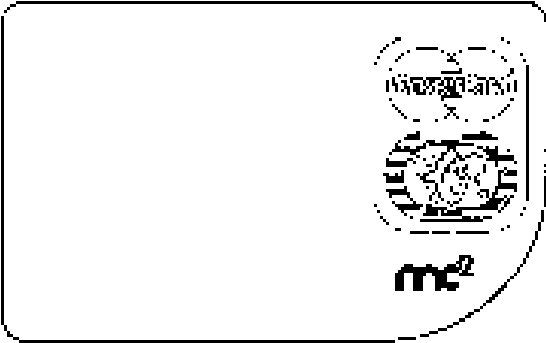
US	2730207	 <p>The mark consists of holographic paper that reflects a spectrum of color in a pattern of oblique, parallel lines. The dotted lines and lining shown in the drawing form no part of the mark, and are for shading or other illustrative purposes only.</p>	34	Eve Holding Corp.	R	2004
US	2910381	 <p>MADE IN ITALY</p> <p>TESSUTO FILODISCOZIA ALTA QUALITA FABRIC</p> <p>The mark consists of stylized wording, a graphic design and a hologram. The graphic symbol comprises a square that contains a central square and is characterized by fanciful half moons that represent fabric in the process of weaving with curved lines converging toward the center from all four sides, such lines representing the yarns; the elements forming the symbol are presented in alternating colors of dark moss, dove gray and pale dove gray; beneath the symbol appears the wording 'TESSUTO FILO DI SCOZIA ALTA QUALITA' in fanciful arrangement with the initial letter "S" of the word "SCOZIA" more dominant and placed in a central position, beneath which is the wording "FABRIC MADE IN ITALY" in gold block letters; below the wording appears a</p>	25	Produttori ..	R	2004

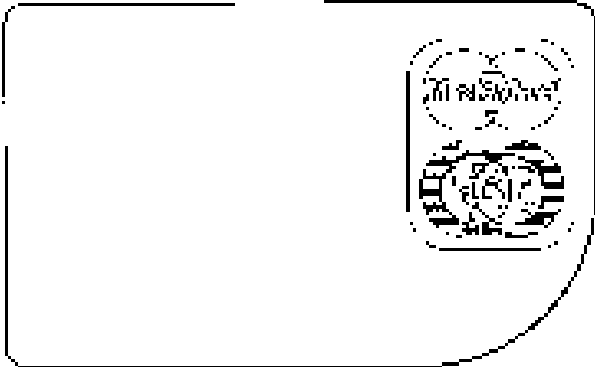

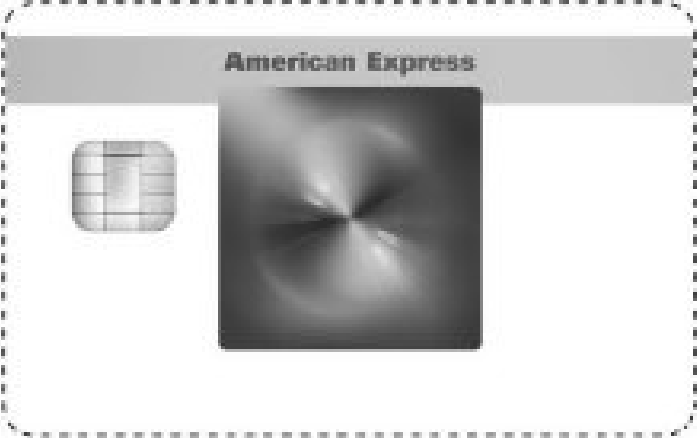
		<p>circular hologram characterized by a tridimensional effect with the wording "MADE IN ITALY" in block capital letters superimposed over a representation of the graphic symbol yarn logo displayed at the top of the label, the entirety of the design being arranged on the substantially rectangular background with rounded corners having a narrow pale dove gray border, the interior of the rectangle comprising a geometric fantasy background consisting of vertical, horizontal and diagonal lines of pale gray color with pale yellow background and the border wording commencing clockwise CERTIFICATE OF GURANTEE, GARANTIEZERTIFIKAT, CERTIFICAT DE GARANTIE, CERTIFICADO DE GARANTIA, Chinese meaning Certificate of Guarantee and GARANTIEBEWIJS</p>				
US	2497918	 <p>The mark consists of a hologram which contains the words FAIR & WHITE HEALTH SECURITY LABO DERMA PARIS.</p>	3	Tancogne, Xavier France	E R	2005
US	75/731306	 <p>The mark consists a checkerboard pattern of uniformly sized silver squares on metallized film that reflect light, thereby creating a hologram design of repeating polygons consisting of various combinations of squares, hexagons, and triangles.</p>	3	Reckit & Colman	E W	2000

US	76/439201		16	Upper Deck Company	E W	2004
US	76671001	 <p data-bbox="488 699 1429 783">iridescent with a silvery overtone. The mark has a hologram feature and the color claimed is iridescent with a silvery overtone</p>	09	Sony DEricson	E W	2007
US	78/122893	 <p data-bbox="488 1185 1435 1364">The mark consists of a distinctive card shape design comprising a rounded lower right corner. The right portion of the card shape design features a holographic device comprising the word MASTERCARD in outline form superimposed across a device comprising two interlocking circles. Positioned directly under the MASTERCARD design is a holographic device comprising a map of the world within two interlocking globes.</p>	9 36	MASTERCARD International	E W	2007

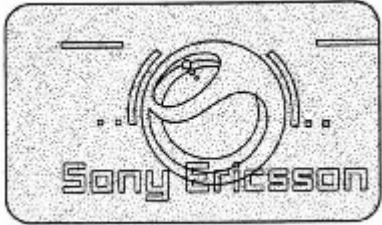

		Please note that the design comprises a drawing of an actual hologram . For security purposes, the MASTERCARD word will not reproduce exactly as embedded within the hologram . The word MASTERCARD photographs as MasterCard and Card Master within the hologram design. A retaining line surrounds both of these design elements. Beneath the holographic device appears the term MC2 appears in the bottom right hand corner of the distinctive card shape..				
US	78/122910	 <p style="text-align: center;">Mastercard</p> <p>The mark consists of a distinctive card shape design comprising a rounded lower right corner. The right portion of the card shape design features a holographic device comprising the word MASTERCARD in outline form superimposed across a device comprising two interlocking circles. Positioned directly under the MASTERCARD design is a holographic device comprising a map of the world within two interlocking globes. Please note that the design comprises a drawing of an actual hologram. For security purposes, the MASTERCARD word will not reproduce exactly as embedded within the hologram. The word MASTERCARD photographs as MasterCard and Card Master within the hologram design. A retaining line surrounds both of these design elements.</p>	9 36	MASTERCARD International	E W	2007

US	78/388126	 <p>The power of dollar</p> <p>The mark consists of Hologram with gold trim design [background], green trim overlay design and dollar sign, gray [dollar]bill insert.</p>	36	Powerdollar	E W	2005
US	3045251	 <p>American Express</p> <p>The mark consists in part of a hologram image in the center of the mark. The stippling is a feature of the mark.</p>	36	American Express	E R	2006
US	3023854	 <p>GOOL shoe corporation</p> <p>Mark comprising a hologram representing spectacles in the place of "OO"</p>	25	Granerreau	E R	2005



US	3015771	 <p data-bbox="488 347 1420 437">Logo consisting of spectacles followed by the term "FOOTWEAR"; trademark comprising a hologram</p>	25	Grannerreau	E R	2005
US	3356528	 <p data-bbox="501 628 689 651">ÉLISE AUCOUTURIER</p> <p data-bbox="555 689 636 715"><i>Lingerie</i></p> <p data-bbox="488 692 1435 948">The color(s) YELLOW, LIGHT PINK, DARK PINK, and BLACK is/are claimed as a feature of the mark.". Square logo consisting of a light pink and dark pink combination; yellow frame of the logo. "The mark consists of of a square design consisting of a LIGHT PINK and DARK PINK combination and the design is framed in YELLOW. The square is made up of LIGHT PINK and DARK PINK sections within a YELLOW frame made up of small sun designs. The stylized ÉLISE AUCOUTURIER LINGERIE wording is in BLACK</p>	25	ELISE AUCOUTURIER	R	2007
US	3407662	 <p data-bbox="488 1209 1397 1321">The color(s) green, purple, orange, yellow, blue and silver is/are claimed as a feature of the mark. The mark consists of a shield in the form of a hologram, the wording/letters appear from left to right in green, purple, orange, yellow, blue and silver. The background of the shield is in silver.</p>	16	McCaffery & Associates	R	2008

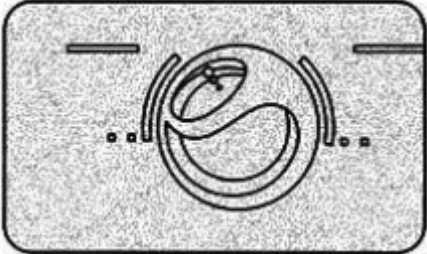

US	76671000	 <p>The stippling in the mark represents a hologram with iridescent effect superimposed on the wording and design elements</p>	9	Sony Ericsson	E W	2007
US	77006890	 <p>Color is not claimed as a feature of the mark. The mark consists of squares in a diamond pattern enclosed by a circle with the wording "smart holograms" below the circle.</p>	1 5 9 10 16	Smart Holograms ltd	E W	2008
US	77185971	 <p>Color is not claimed as a feature of the mark. The mark consists of squares in a diamond pattern enclosed by a circle, wherein the squares are shown in two different shades in an arrangement to display a S representation in the middle, with the wording "smart holograms" below the circle.</p>	1 5 9 10 16	Smart Holograms ltd	E W	2008



US	77252286	 <p>The color(s) Gold, green, orange, bronze and red is/are claimed as a feature of the mark. The mark consists of a reflective hologram with a gold background with circles in shades of green, orange and bronze and the word "GLAMOURAZZI" in red.</p>	3	Beauty Bank Inc.	E W	2009
US	3487574	 <p>The color(s) Blue, Navy Blue, Silver is/are claimed as a feature of the mark. The mark consists of Computer Wizard with hologram futuristic screen and computer with double keyboard typing</p>	35	Fernando Robles	E R	2008
US	77289827	 <p>The color(s) Blue, Navy Blue, Silver is/are claimed as a feature of the mark. The mark consists of Computer Wizard with hologram futuristic screen and computer with double keyboard typing</p>	42	Fernando Robles	E W	2008

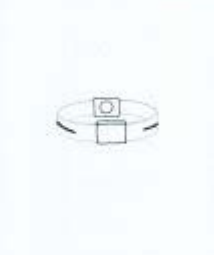

US	3628131	 <p>Color is not claimed as a feature of the mark. The mark consists of design elements and a hologram. The stippling in the mark represents a hologram with iridescent effect superimposed on the design elements</p>	9	Sony Ericsson Mobile Communications AB Corporation	E R	2009
US	3888210	 <p>The mark consists of hexagonal or beehive main patterns with occasional six-pointed stars spread in an alternate mode. Other six-pointed small stars are placed within the occasional stars. Each nodal point of the patterns is thick-dotted. Another set of hexagonal or beehive shade patterns are spread in multi-lined hatching mode and overlapped in contract to the main patterns. The shade patterns are crossed over with the main patterns such that the main patterns also forms cubic hologram images.</p>	18	VL & CO Corporation CORPORATION REPUBLIC OF KOREA	E R	2010
US	3747810	 <p>. The color(s) black, gold, orange, red, yellow, green, blue, indigo, white, beige and violet is/are claimed as a feature of the mark. The mark consists of a horizontal black rectangle containing the words "MAHMOOD TEA" in white, at</p>	30	Altunkaya Insaat Nakliyat Gida Ticaret Anonim Sirketi	E R	2010



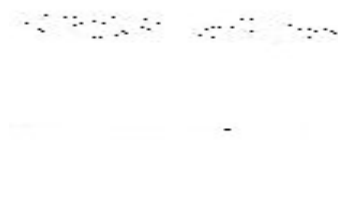

		<p>the top of the drawing. Three vertical rectangles appear below the black rectangle, the outer two of which are beige in color and the inner rectangle is gold on the top portion and orange towards the bottom. In the center of the drawing is a diamond shaped design with the letter "M" in gold on a black background and a translucent border. A cup of tea in a glass mug appears superimposed over the bottom half of the gold letter "M." A thin horizontal gold rectangle appears below the center design near the bottom of the drawing and flows across the three vertical rectangles. A circle design in gold and black appears towards the upper right hand corner of the beige vertical rectangle with the wording ALTUNKAYA GROUP OF COMPANIES in black, which wraps around the border of this design. A picture of a building in black and gold appears in the center of the circle design. Below this design in the bottom right corner of the beige vertical rectangle is a square with the colors red, orange, yellow green, blue, indigo and violet appearing in rainbow form in a hologram design element with the identical circle design described above, however, the design and wording is in white. The words MAHMOOD TEA appears above the circle design in white, also within the hologram design element.</p>				
US	78909404	 <p>The mark consists of a hologram of concentric circles applied to the packaging.</p>	28	Nike Inc.	E W	2007

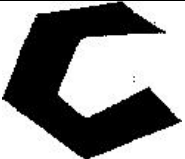

US	79018732	 <p>Mark comprising a hologram; the vignettted green is the background colour; the logo in the shape of a gilded pear; the strip border in the form of a rectangular chain in gold.</p>	16 21 24 30 32	D et S S.a.r.l	E W	2006
US	3737020	 <p>The trademark KOODBULL is a semi-figurative mark comprising a hologram reproducing a head butt; the principal colours are blue, white and red; green, white and red; the trademark is available in several versions in addition to the principal colours of the initial filing, in particular in green-yellow-red etc.</p>	25 28	BOUHAMA SAID UNKNOWN	E R	2010
US	3654876	 <p>Color is not claimed as a feature of the mark. Mark comprising a</p>	16 25 38	LE RIDOU BONNAUDEAU Frédéric	E R	2009

US	85130702	<p>hologram - "NOT SLAVE".</p>  <p>The mark consists of The mark consists of three-dimensional design features of a wristband or bracelet comprising two non-functional horizontally-oriented rectangular shapes positioned 180 degrees opposite one another and two non-functional curved lines. Each line is positioned in the middle of the wristband or bracelet and runs around part of the exterior circumference of the goods and is placed 180 degrees opposite the other line. Each line is positioned between the rectangular shapes but does not extend to touch the side edges of the rectangular shapes. Circular holograms are also positioned on the interior portion of the rectangular blocks. The matter appearing in dotted lines is not part of the mark and serves only to show the position of the mark on the goods.</p>	14 25	EFX Performance Inc	E	2012
US	85130715	 <p>The mark consists of Non-Functional oval in center of the product with double non-functional colored lines extending around the circumference of the product with a hologram positioned on the back of the oval</p>	14	EFX Performance Inc	E	2012

US	85130723	 The mark consists of Non-functional oval positioned in the center of the product with a single colored line around the circumference of the oval and additional single colored lines extending around the circumference of the product on both the inside and the outside of product and one hologram positioned on the interior of the oval.	1254 25	EFX Performance Inc	E	2012
US	85130733	 The mark consists of Non-functional oblong shaped badges mounted 180 degrees opposite one another on the product, which each badges contains one hologram positioned on the right side of the badge and such hologram is encased by a single non-functional colored line around its circumference.	14 25	EFX Performance Inc	E	2012
WO	545211	 L'hologramme est constitué de rectangles successivement bleu et vert sous incidence perpendiculaire. Sous les autres angles d'incidence, les couleurs varient selon la loi $\lambda \cos i$ où λ est la longueur d'onde de la lumière et i l'angle d'incidence (en radians)., bleu et vert	9 16 36	GROUPEMENT DES CARTES BANCAIRES	R	1989

WO	683249	 <p>Marque comportant un hologramme</p>	9 16 36 38	GROUPEMENT DES CARTES BANCAIRES	R	1997
WO	695878	 <p>Mark consisting of a hologram.</p>	3 24 25	NitYa	R	1998
WO	766623	 <p>Mark filed in colour; mark comprising a hologram.</p>	29 30 31	Generale Traiteur	R	2001
WO	775608	 <p>Trademark consisting of a hologram</p>	25	Granereau	R	2002

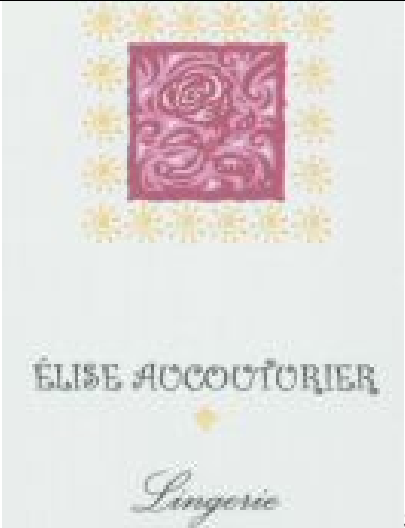
WO	812689	 <p>The trademark comprises a hologram</p>	10	Alfred Pfennig	R	2003
WO	820025	 <p>Mark comprising a hologram representing spectacles in the place of "OO"</p>	25	Granerreau	R	2004
WO	825418	 <p>Logo consisting of spectacles followed by the term "FOOTWEAR"; trademark comprising a hologram</p>	25	Granerreau	R	2004
WO	871099	 <p>Mark comprising a hologram; the vignettted green is the background colour; the logo in the shape of a gilded pear; the strip border in the form of a rectangular chain in gold.</p>	16 21 24 30	D et S Sarl	R	2006

<p>WO</p>	<p>888562</p>	 <p>Square made up of light pink and dark pink sections within a yellow frame made up of small suns, the trademark comprising a hologram. Carré fait de roses claires et roses foncées entouré d'un cadre jaune fait de petits soleils, la marque comportant un hologramme.</p>	<p>25</p>	<p>Elise Aucouturier</p>	<p>R</p>	<p>2006</p>
<p>WO</p>	<p>932309</p>	 <p>The colour blue extends from above the head of the hologram to the left foot and outlines the curve of the left leg; the colour red extends from above the head of the hologram to the right foot and outlines the curve of the right leg.</p>	<p>25 28</p>	<p>BOUHMAMA SAID UNKNOWN FRANCE</p>	<p>R</p>	<p>2007</p>

WO	961381	 <p data-bbox="660 411 1182 437">Mark comprising a hologram - "NOT SLAVE".</p>	16 25 38	LE RIDOU BONNAUDEAU Frédéric	R	2008
----	--------	------------------------------------------------------------------------------------------------------------------------------------------------------------------------	----------	------------------------------------	---	------

*

W = zurückgezogen oder zurückgewiesen, withdrawn or rejected

R = eingetragen, registered

E = geprüft, examination

A = Beschwerde, Appeal

O = im Widerspruch, opposition